

R.S.ELECTRICAL (RSE) LTD.

SPECIALIST SUPPLIERS TO THE RAIL INDUSTRY.

**UNIT 3, BROOKSIDE INDUSTRIAL
ESTATE,
STATION STREET,
LONGPORT,
STOKE-ON-TRENT,
ST6 4ND.**

TEL. 01782 575316

FAX. 01782 834201

E-MAIL. rseltd@btconnect.com

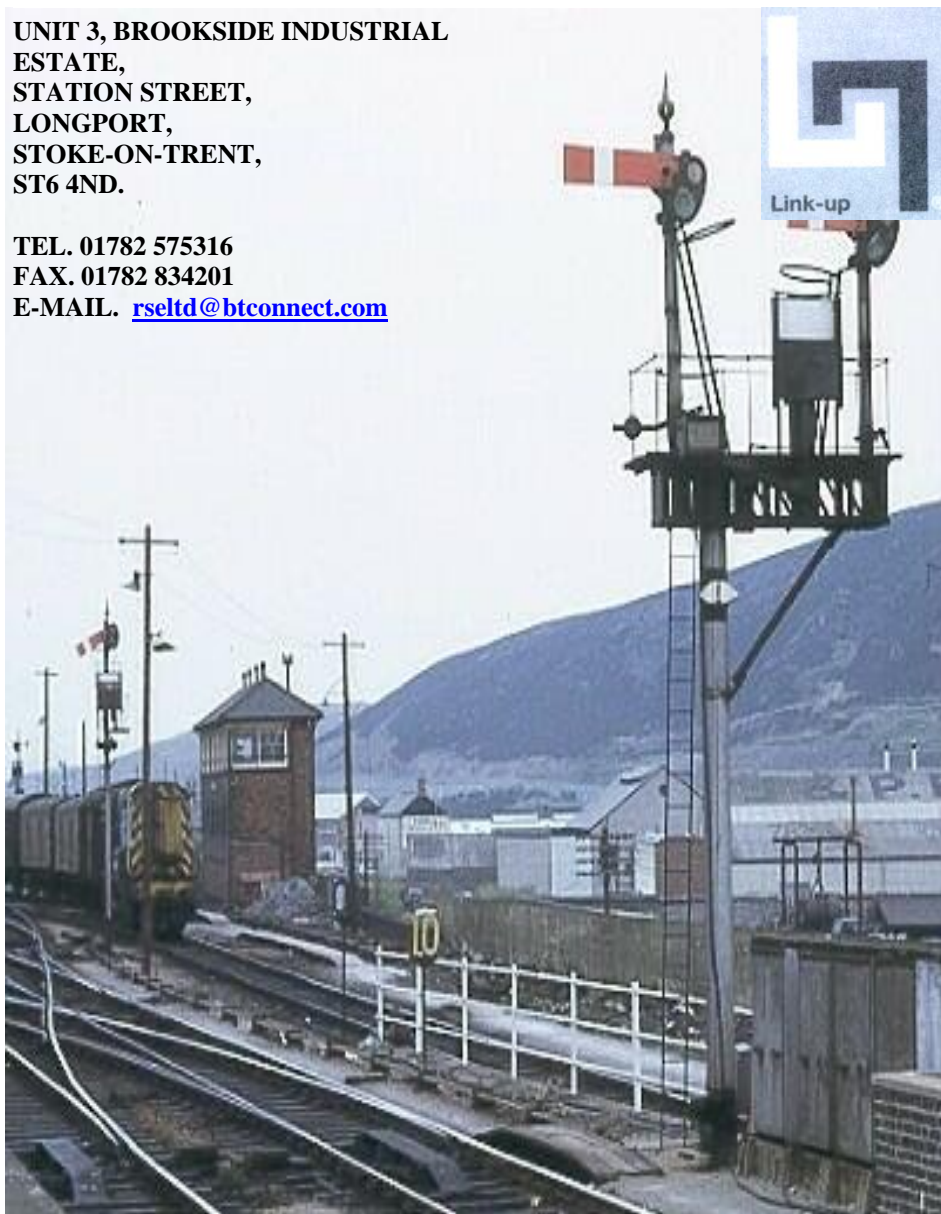

For price and delivery contact sales.

TEL:- (01782) 575316 FAX:- (01782) 834201 E-MAIL:-rseltd@btconnect.com

R.S.ELECTRICAL (RSE) LTD.

SPECIALIST SUPPLIERS TO THE RAIL INDUSTRY.



CERTIFICATE OF REGISTRATION

LINK-UP QUALIFICATION SCHEME

R S Electrical (RSE) Ltd

Supplier Number: 19485



Issue Date: 13/11/2006
Expiry Date: 10/09/07
Certificate Number: 23087-19485/22879

Peter Brookes
Rail Sector Manager
Achilles Information Limited

*This is not a legal document and cannot be used as such.
To check the validity of this certificate please visit www.rail.achilles.com*



For price and delivery contact sales.

TEL:- (01782) 575316 FAX:- (01782) 834201 E-MAIL:- rseltd@btconnect.com

Return to top

R.S.ELECTRICAL (RSE) LTD.

SPECIALIST SUPPLIERS TO THE RAIL INDUSTRY.



CONTENTS.

SECTION 1.

LOCATION CASES.

| | |
|-----------|--|
| PAGE 1. | LOCATION CASE ACCESSORIES. |
| PAGE 2. | LOCATION CASE HEATERS. TOUCH UP PAINT. |
| PAGE 3. | EARTHING PRODUCTS. ELECTRICAL INSULATION TAPE. |
| PAGE 4. | ENTRELEC DATA SURGE PROTECTION. LUBRICANTS, CLEANERS AND INSULATION FILL. |
| PAGE 5. | NYLON FIXINGS. |
| PAGE 6. | STAINLESS STEEL FIXINGS. SPANNERS. |
| PAGE 7-8. | STAINLESS STEEL LOC FITTINGS |
| PAGE 9. | BROTHER LABELLING MACHINES AND TAPES. |

SECTION 2.

TERMINALS.

| | |
|-----------|---------------------|
| PAGE 1-4. | ENTRELEC TERMINALS. |
| PAGE 5-6. | TERMINALS. |

SECTION 3.

FUSE HOLDERS AND FUSES.

| | |
|---------|--------------------------------------|
| PAGE 1. | BUSSMAN FUSE HOLDERS AND FUSE LINKS. |
| PAGE 2. | ENTRELEC TERMINAL FUSELINKS. |

SECTION 4.

POWER BOXES.

| | |
|---------|--|
| PAGE 1. | ABB ENCLOSED SWITCHES, SPREADER BOXES. |
| PAGE 2. | SIG1-10 POWER BOXES. |
| PAGE 3. | BOMBARDIER POWER ENCLOSURES. |

SECTION 5.

ENCLOSURES.

| | |
|-----------|-----------------------------|
| PAGE 1-2. | ST BOXES. |
| PAGE 2. | STAINLESS STEEL ENCLOSURES. |

For price and delivery contact sales.

TEL:- (01782) 575316 FAX:- (01782) 834201 E-MAIL:- rseltd@btconnect.com

Return to top

R.S.ELECTRICAL (RSE) LTD.

SPECIALIST SUPPLIERS TO THE RAIL INDUSTRY.



CONTENTS.

SECTION 6. CABLES.

- PAGE 1. 6491B,6491X,TRI-RATED AND TYPE 3 SIGNALLING CABLES
- PAGE 2. A1,A2 AND A3 RAILWAY SIGNALLING CABLE.
- PAGE 3-4. B1 AND B2 LINESIDE CABLING.
- PAGE 5. C1,C2 AND C3 TYPE CABLES.
- PAGE 6. TYPE D1 AND D2 CABLES.
- PAGE 7. TYPE E1,E2 AND E3 CABLES.
- PAGE 8. TRACK FEEDER CABLES,POWER CABLES,CABLE CLEANERS.

SECTION 7. SPECIALIST TRACKSIDE PRODUCTS.

- PAGE 1-2. TRACKSIDE DISCONNECTION BOXES.
- PAGE 3-4. PRE-TERMINATED TRACK CONNECTION CABLES.
- PAGE 5. PRE-TERMINATED DETECTION SYSTEM CABLES.
- PAGE 6-8. POINTS HEATING.
- PAGE 9-10. DISCONNECTS FOR POINTS MACHINES.
- PAGE 11. P CLIPS AND FASTENINGS.

SECTION 8. CRIMPS,CLAMPS AND CRIMPING TOOLS.

- PAGE 1. AMP PIDG CRIMP TERMINALS.
- PAGE 2. CRIMPING TOOLS,STORAGE BOXES.
- PAGE 3. NYLON CRIMPS.
- PAGE 4. UN-INSULATED CRIMP LUGS.
- PAGE 5. CRIMPING TOOLS AND DIE SETS.
- PAGE 6. POWER CABLE CRIMPS.
- PAGE 7. CABLE LINKS (THROUGH CONNECTORS).

For price and delivery contact sales.

TEL:- (01782) 575316 FAX:- (01782) 834201 E-MAIL:-rseltd@btconnect.com

[Return to top](#)



CONTENTS.

SECTION 9. CABLE MANAGEMENT.

- PAGE 1. CLOSED SLOT BETADUCT (GREY).
- PAGE 2. CLOSED SLOT BETADUCT (BLACK).
- PAGE 3. PLAIN BETADUCT.
- PAGE 4. NORYL BETADUCT.
- PAGE 5. BETADUCT DIVIDERS AND END PLATES.
- PAGE 6. GROMMET STRIP AND SPIROBAND.
- PAGE 7. EGA HEAVY DUTY PLAIN CABLE DUCTING.
- PAGE 8. LPA TRAY.
- PAGE 9. MITA HEAVY DUTY PVC CABLE TRAY AND ACCESSORIES
- PAGE 10. MITA GRP ELEVATED CABLE TROUGHING.
- PAGE 11-12. STEEL CABLE TRAY AND ACCESSORIES.
- PAGE 13. PMA CONDUIT AND FITTINGS.
- PAGE 14. PMA ZERO HALOGEN CONDUIT AND FITTINGS.

SECTION 10. CABLE IDENTIFICATION.

- PAGE 1-4. SIZE 9-18 CABLE MARKERS.
- PAGE 5. SPECIAL MARKERS.
- PAGE 6. FLEXIMARK CABLE CARRIERS, MARKER APPLICATORS.
CABLE MARKER STORAGE BOXES.

For price and delivery contact sales.

TEL:- (01782) 575316 FAX:- (01782) 834201 E-MAIL:- rseltd@btconnect.com

R.S.ELECTRICAL (RSE) LTD.

SPECIALIST SUPPLIERS TO THE RAIL INDUSTRY.



CONTENTS.

SECTION 11. HEATSHRINK AND SLEEVING PRODUCTS.

- PAGE 1. HEAT SHRINK CABLE GLANDS AND CABLE END CAPS.
- PAGE 2. JOINTING KITS.
- PAGE 3. HEAT SHRINK TUBING, MOISTURE BARRIER KITS.
- PAGE 4. BRAIDED SLEEVING, CLEAR TUBING, RUBBER SLEEVING.
- PAGE 5. CABLE CLAMPS.
- PAGE 6. CABLE TIES AND BASES.

SECTION 12. HILTI RAIL PRODUCTS.

- PAGE 1-3. HILTI TOOLS AND FIXINGS.

SECTION 13 ACCOUNT APPLICATION FORM AND CONDITIONS OF SALE

For price and delivery contact sales.

TEL:- (01782) 575316 FAX:- (01782) 834201 E-MAIL:-rseltd@btconnect.com

Return to top

R.S.ELECTRICAL (RSE) LTD.

SPECIALIST SUPPLIERS TO THE RAIL INDUSTRY.



SECTION 1

LOCATION CASE ACCESSORIES

| | |
|-----------|--|
| PAGE 1. | LOCATION CASE ACCESSORIES. |
| PAGE 2. | LOCATION CASE HEATERS. TOUCH UP PAINT. |
| PAGE 3. | EARTHING PRODUCTS. ELECTRICAL INSULATION TAPE. |
| PAGE 4. | ENTRELEC DATA SURGE PROTECTION. LUBRICANTS, CLEANERS AND INSULATION FILL. |
| PAGE 5. | NYLON FIXINGS. |
| PAGE 6. | STAINLESS STEEL FIXINGS. SPANNERS. |
| PAGE 7-8. | STAINLESS STEEL LOC FITTINGS |
| PAGE 9. | BROTHER LABELLING MACHINES AND TAPES. |

For price and delivery contact sales.

TEL:- (01782) 575316 FAX:- (01782) 834201 E-MAIL:-rseltd@btconnect.com

Return to top

R.S.ELECTRICAL (RSE) LTD.

SPECIALIST SUPPLIERS TO THE RAIL INDUSTRY.

LOCATION CASE AND ACCESSORIES



BR.RSE-1



BR.RSE-2



BR.RSE-3



BR.RSE-6, 7



BR.STCFS2



BR.STC1431



BR.STCSMC512



BR.RSE-4



BR.STCDP118/110V



BR.DT495/MB

| BR.CAT.No. | RSE.CAT.No. | DESCRIPTION | |
|------------|------------------|---|--|
| | BR.RSE-1 | 60x130mm BLANK TUFNOL BOARD | |
| | BR.RSE-2 | LOCATION SWITCH ON TUFNOL BOARD | |
| | BR.RSE-3 | LOCATION LAMP ON TUFNOL BOARD | |
| | BR.RSE-4 | RESISTOR BOARD | |
| | BR.RSE-5 | TEST POINT FOR R.E.B'S | |
| | BR.RSE-6 | 460mm EARTH BAR | |
| | BR.RSE-7 | 1.2M EARTH BAR | |
| | BR.STC1431 | B.C.LAMPHOLDER WITHOUT BOARD | |
| | BR.STC4005/4177 | LOCATION LIGHT SWITCH WITHOUT BOARD | |
| | BR.STCSMC512 | METAL CLAD LOCATION LIGHT SWITCH | |
| | BR.110V/60WBC | 110V 60W LOCATION LIGHT BULB | |
| | BR.STCDP118/110V | FLUORESCENT LIGHT FITTING FOR FULL LOC. | |
| | BR.T818W2FT | 18WATT REPLACEMENT LIGHT TUBE | |
| | BR.STCTLP8/110V | FLUORESCENT LIGHT FITTING FOR HALF LOC. | |
| | BR.STCFS2 | REPLACEMENT FLUORESCENT STARTER | |
| | BR.DT495/MB | 495mm LONG DIAGRAM TUBE | |
| | BR.DT625/MB | 625mm LONG DIAGRAM TUBE | |
| | BR.R-495/SC+PC | 495mm DIAGRAM TUBE WITH SPRING CLIP | |
| | BR.RSE11A | B.C.LAMPHOLDER & LIGHT SW UNWIRED BRD. | |
| | BR.RSE11B | B.C LAMPHOLDER & LIGHT SW.WIRED BRD | |
| | BR.T88W18 | 8WATT REPLACEMENT TUBE | |
| | BR.RSE-12 | DIAGRAM TUBE MOUNTING BRACKET | |

For price and delivery contact sales.

TEL:- (01782) 575316 FAX:- (01782) 834201 E-MAIL:- rseltd@btconnect.com

R.S.ELECTRICAL (RSE) LTD.

SPECIALIST SUPPLIERS TO THE RAIL INDUSTRY.

LOCATION CASE AND ACCESSORIES



Location Case Heaters

| BR.CAT.No | RSE.CAT.No. | DESCRIPTION | |
|-----------|----------------|-------------------------------|--|
| 55/00971 | ELDONACH20110V | 20W 110V LOCATION CASE HEATER | |
| 55/007963 | ELDONACH30110V | 30W 10V LOCATION CASE HEATER | |
| | ELDONACH80230V | 80W 230 LOCATION CASE HEATER | |

LOC Case Touch-up Paint

| BR.CAT.No | RSE.CAT.No. | DESCRIPTION | |
|-----------|-------------|--------------------------------|--|
| | BR.81458 | Henry Williams Rail Grade Grey | |
| | | | |

For price and delivery contact sales.

TEL:- (01782) 575316 FAX:- (01782) 834201 E-MAIL:- rseltd@btconnect.com

R.S.ELECTRICAL (RSE) LTD.

SPECIALIST SUPPLIERS TO THE RAIL INDUSTRY.



Earthing Products



| BR.CAT.No | RSE.CAT.No | DESCRIPTION | |
|-----------|------------|---------------------------------------|--|
| 4/26050 | PT006/9 | CONCRETE INSPECTION PIT | |
| | BR.PT205 | LIGHTWEIGHT PLASTIC INSPECTION PIT | |
| 54/117510 | RC010 | 15mm x 1200mm SOLID COPPER ROD | |
| 54/117540 | CG013 | INTERNAL COUPLING DOWEL | |
| 54/117530 | ST010 | 15mm DRIVING STUD | |
| 54/117550 | SP010 | 15mm SPIKE | |
| 54/117532 | CR700 | TYPE 'GUV' CONNECTOR CLAMP | |
| | BR.CR305 | 16mm TYPE 'E' CONNECTOR | |
| | BR.TC030S | 25mm X 3mm X 20M COPPER TAPE | |
| | BR.PE110 | 600mm x 600mm x 3mm LATTICE EARTH MAT | |
| 50/000427 | PE120 | 900mm x 900mm x 3mm LATTICE EARTH MAT | |
| 50/000426 | PE020 | 900mm x 900mm x 3mm EARTH PLATE | |
| | BR.SSEC15 | OUTDOOR EARTH CLAMP | |
| | BRCM025 | 25Kg SACK OF MARKANITE | |

Electrical Insulating Tape

| BR.CAT.No | RSE.CAT.No. | DESCRIPTION | |
|-----------|--------------|-----------------|--|
| | BR.SAT 1932* | 9mm x 33metres | |
| | BR.SAT 1933* | 19mm x 33metres | |
| | BR.SAT 1934* | 25mm x 33metres | |

* Please State Colour When Ordering.

For price and delivery contact sales.

TEL:- (01782) 575316 FAX:- (01782) 834201 E-MAIL:- rseltd@btconnect.com

R.S.ELECTRICAL (RSE) LTD.

SPECIALIST SUPPLIERS TO THE RAIL INDUSTRY.

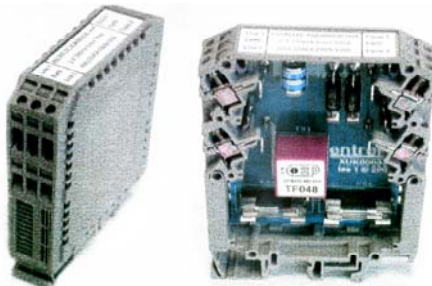

ENTRELEC DATA SURGE PROTECTION

| BR.CAT.No | RSE.CAT.No. | DESCRIPTION | |
|-----------|-----------------|------------------------------|--|
| 88/015354 | ENTRELXUK000330 | DATA SURGE PROTECTION DEVICE | |

DEVICE FOR USE WITH SIGNALLING SYSTEMS INCLUDING HOT AXLE BOX, DETECTORS (HABD), TIME DIVISION MULTIPLEX SYSTEMS (TDM), AND TRAIN DESCRIBERS (TD).



Lubricants, Cleaners & Insulation Fill

| BR.CAT.No | RSE.CAT.No. | DESCRIPTION | |
|-----------|-------------------|-----------------------------|--|
| | BR.259625 | CF125-50 FIRE RATED FOAM. | |
| | BR.259768 | CFDS1 FOAM GUN | |
| | BR.024S06 | CFR-1 FOAM CLEANER | |
| | BR.TECTYL AEROSOL | LUBRICANT | |
| | BR.OPTIROC LWA | LIGHTWEIGHT INSULATION FILL | |

For price and delivery contact sales.

TEL:- (01782) 575316 FAX:- (01782) 834201 E-MAIL:- rseltd@btconnect.com

R.S.ELECTRICAL (RSE) LTD.

SPECIALIST SUPPLIERS TO THE RAIL INDUSTRY.



Nylon Fixings

| BR.CAT.No | RSE.CAT.No. | DESCRIPTION | |
|-----------|-------------|--|--|
| | BR.M6X12 | M6 x 12mm Long Nylon Cheese Head Screw | |
| | BR.M6WSH | M6 Nylon Washer | |
| | BR.M6DMT | M6 Nylon Dome Nut | |
| | BR.M6X25/N | M6 x 25mm Long Nylon Cheese Head Screw | |

Other Sizes Available On Request

BA to Metric Conversion Table

6BA = M2.5 5BA = M3 4BA = M3.5 3BA = M4 2BA = M5 0BA = M6

For price and delivery contact sales.

TEL:- (01782) 575316 FAX:- (01782) 834201 E-MAIL:-rseltd@btconnect.com

R.S.ELECTRICAL (RSE) LTD.

SPECIALIST SUPPLIERS TO THE RAIL INDUSTRY.



Stainless Steel Fixings

| BR.CAT.No. | RSE.CAT.No. | DESCRIPTION | |
|------------|-------------|------------------------------|--|
| | BR.M5X12 | M5x12mm CHEESE HEAD SCREW | |
| | BR.M5X25 | M5x25mm CHEESE HEAD SCREW | |
| | BR.M5X40 | M5x40mm CHEESE HEAD SCREW | |
| | BR.M5SW | M5 SPRING WASHER | |
| | BR.M5W | M5 PLAIN WASHER | |
| | BR.M5N | M5 NUT | |
| | BR.M6X12 | M6x12mm CHEESE HEAD SCREW | |
| | BR.M6X25 | M6x25mm CHEESE HEAD SCREW | |
| | BR.M6X40 | M6x40mm CHEESE HEAD SCREW | |
| | BR.M6SW | M6 SPRING WASHER | |
| | BR.M6W | M6 PLAIN WASHER | |
| | BR.M6N | M6 NUT | |
| | BR.2BAX3/4 | 2BA x 3/4" CHEESE HEAD SCREW | |
| | BR.2BAN | 2BA NUT | |

Other Sizes Available On Request

Tools

| BR.CAT.No | RSE.CAT.No. | DESCRIPTION | |
|-----------|-------------|------------------|--|
| | BR.2BANS | 2BA NUT SPINNER | |
| | BR.0BANS | 0BA NUT SPINNER | |
| | BR.13NS | 13mm NUT SPINNER | |

BA to Metric Conversion Table

6BA = M2.5 5BA = M3 4BA = M3.5 3BA = M4 2BA = M5 0BA = M6

For price and delivery contact sales.

TEL:- (01782) 575316 FAX:- (01782) 834201 E-MAIL:- rseltd@btconnect.com

R.S.ELECTRICAL (RSE) LTD.

SPECIALIST SUPPLIERS TO THE RAIL INDUSTRY.

Stainless Steel LOC Fittings



| BR.CAT.No. | RSE.CAT.No. | DESCRIPTION | |
|-------------|-------------|--|--|
| 86/43580-B1 | | SLOTTED UPRIGHT CHANNEL | |
| 86/43583-B4 | | SLOTTED CHANNEL UPRIGHT | |
| 86/43584-B5 | | PLAIN HORIZONTAL CHANNEL (8 PER. A.R.) | |
| 86/43516-C1 | | EQUIPMENT SHELF RAIL | |
| 86/43515-C2 | | BATTERY SHELF RAIL | |
| 86/43519-C3 | | LARGE TRANSVERSE TIE BAR | |
| 86/43547-C4 | | SHORT TRANSVERSE TIE BAR | |
| 86/43585-C7 | | LONG CANTILEVER ARM | |
| 86/43586-C8 | | SHORT CANTILEVER ARM | |
| 86/43535-D1 | | LARGE CROSSBAR | |
| 86/43534-D2 | | SHORT CROSSBAR | |
| 86/43553-D3 | | INTERMEDIATE UPRIGHT | |
| 86/43524-E1 | | LARGE EQUIPMENT RAIL | |
| 86/43523-E2 | | SMALL EQUIPMENT RAIL | |
| 86/43536-F1 | | LARGE TERMINAL CROSSBAR | |
| 86/43537-F2 | | SHORT TERMINAL CROSSBAR | |
| 86/42055-F3 | | TERMINAL RAIL 14 x 2BA | |
| 86/42056-F4 | | TERMINAL RAIL 30 x 2BA | |
| 86/42057-F5 | | TERMINAL RAIL 48 x 2BA | |
| 86/43574-F6 | | FITTING | |
| 86/43546-G1 | | RAIL RELAY LARGE TOP/BOTTOM | |
| 86/43544-G2 | | RAIL RELAY LARGE INTERMEDIATE | |
| 86/43545-G3 | | RAIL RELAY SMALL TOP/BOTTOM | |
| 86/43543-G4 | | RAIL RELAY SMALL INTERMEDIATE | |
| 86/43542-G5 | | LARGE INTERMEDIATE RAIL AND PLATE | |
| 86/43569-G6 | | SMALL INTERMEDIATE RAIL AND PLATE | |
| 86/43513-H1 | | AC TRACK RELAY PLATE | |
| 86/43514-H2 | | SS1 FUSE MOUNTING PLATE | |
| 86/9974-H3 | | TOPHAT RAIL AND MOUNTING PLATE | |
| 86/43568-H4 | | FUSE HOLDER AND BUSBAR MOUNTING PLATE | |
| 86/43587-H5 | | RELAY RAIL ADJUSTABLE CLAMP | |
| 86/43589-H7 | | TRACK CAPACITOR MOUNTING PLATE | |
| 86/43590-H8 | | AC TRACK FEEDER BRACKET | |
| 86/43518-J1 | | LARGE SSI RAIL | |
| 86/43517-J2 | | SMALL SSI RAIL | |
| 86/43552-K1 | | LARGE LABEL RAIL | |
| 86/43551-K2 | | SMALL LABEL RAIL | |
| 86/43564-L1 | | LARGE TOPHAT MOUNTING RAIL | |

For price and delivery contact sales.

TEL:- (01782) 575316 FAX:- (01782) 834201 E-MAIL:- rseltd@btconnect.com

R.S.ELECTRICAL (RSE) LTD.

SPECIALIST SUPPLIERS TO THE RAIL INDUSTRY.



Stainless Steel LOC Fittings

| BR.CAT.No. | RSE.CAT.No. | DESCRIPTION | |
|--------------|-------------|--|--|
| 86/43565-L2 | | SMALL TOPHAT MOUNTING RAIL | |
| 86/43566-L3 | | VERTICAL TOPHAT MOUNTING RAIL | |
| 86/43557-M1 | | OFFSET CHANNEL FIXING FOR WIRING | |
| 86/43554-M2 | | DIRECT FIXING FOR WIRING (BAG OF 10) | |
| 86/43555-M3 | | M6 CHANNEL RAIL FIXING (BAG OF 10) | |
| 86/43556-M4 | | M8 FIXING (BAG OF 10) | |
| 86/43592-M6 | | SQUARE NECK FITTINGS (BAG OF 10) (SIGNALLING) | |
| 86/43593-M7 | | SQUARE NECK FITTINGS (WIRING DUCTS) | |
| 86/43522-P1 | | LARGE POWER CABLE BAR | |
| 86/43521-P2 | | SMALL POWER CABLE BAR | |
| 86/43567-P3 | | LARGE DOUBLE CABLE BAR | |
| 86/43586-P4 | | MOUNTING FRAME FOR POWER DISTRIBUTION UNIT | |
| 86/43558-R1 | | FITTING | |
| 86/43559-R2 | | FLOOR FIXING (8 PER A.R.) | |
| 86/43560-R3 | | FLOOR SUPPORT PLATE (4 PER A.R.) | |
| 86/43561-R4 | | WALL FIXING PLATE (8 PER A.R.) | |
| 86/43562-R5 | | FITTING | |
| 86/43563-R6 | | FLAT DUCT MOUNTING PLATE (20 PER A.R.) | |
| 86/43594-R7 | | OFFSET DUCT MOUNTING | |
| 86/43595-R8 | | BRACKET WITH LONG + SHORT SCREWS (8 PER A.R.) | |
| 86/43596-R9 | | BRACKET WITH LONG SCREWS (8 PER A.R.) | |
| 86/43612-R18 | | LEFT HAND SECURING BRACKET | |
| 86/43613-R19 | | RIGHT HAND SECURING BRACKET | |
| 86/9973-S1 | | LARGE BATTERY SHELF (LOC) | |
| 86/9972-S2 | | SMALL BATTERY SHELF (LOC) | |
| 86/9970-S3 | | LARGE BATTERY SHELF (REB) | |
| 86/43611-T1 | | TERMINATION PLATE FOR DC TRACK CIRCUIT | |
| 86/43597-T2 | | TERMINATION MOUNTING PLATE FOR DC (AC IMMUNE) TRACK CIRCUIT. | |
| 86/43598-T3 | | RELAY RECEIVER MOUNTING PLATE FOR GEC HVI TC'S | |
| 86/9977-U1 | | LARGE 29 x BS714 FUSEHOLDERS RAIL | |
| 86/9976-U2 | | SMALL 14 x BS714 FUSEHOLDERS RAIL | |
| 86/9975-U3 | | LARGE 20 x BS88 FUSEHOLDERS RAIL | |
| 86/9979-U4 | | SMALL 10 x BS88 FUSEHOLDERS RAIL | |
| 86/9978-V1 | | FEED UNIT VERTICAL RAIL | |
| 50/000329 | | BUSBAR | |
| | | | |

For price and delivery contact sales.

TEL:- (01782) 575316 FAX:- (01782) 834201 E-MAIL:- rseltd@btconnect.com

R.S.ELECTRICAL (RSE) LTD.

SPECIALIST SUPPLIERS TO THE RAIL INDUSTRY.



BROTHER LABELLING TAPES

| BR.CAT.No | RSE.CAT.No. | DESCRIPTION | |
|------------------|--------------------|---------------------|--|
| | BROTZ221 | 9mm BLACK ON WHITE | |
| | BROTZ222 | 9mm RED ON WHITE | |
| | BROTZ231 | 12mm BLACK ON WHITE | |
| | BROTZ232 | 12mm RED ON WHITE | |
| | BROTZ241 | 18mm BLACK ON WHITE | |
| | BROTZ242 | 18mm RED ON WHITE | |
| | | | |
| | BRO2450DX | LABELLING MACHINE | |
| | BRO2460DX | LABELLING MACHINE | |
| | BRO2480DX | LABELLING MACHINE | |

We are also able to supply many other labelling tapes and machines, please contact us for details.

For price and delivery contact sales.

TEL:- (01782) 575316 FAX:- (01782) 834201 E-MAIL:- rseltd@btconnect.com

R.S.ELECTRICAL (RSE) LTD.

SPECIALIST SUPPLIERS TO THE RAIL INDUSTRY.



SECTION 2 **TERMINALS**



THIS SECTION ILLUSTRATES THE COMPREHENSIVE RANGE OF TERMINALS AVAILABLE IN BOTH ENTRELEC WAGO. WE HOLD EXTENSIVE STOCKS OF ALL THE PRODUCTS ILLUSTRATED, AND CAN OFFER YOU ANY TECHNICAL BACKUP THAT YOU MAY REQUIRE. WE CAN ALSO SUPPLY KLIPPON TERMINALS TO ORDER.

PAGE 1-4. ENTRELEC TERMINALS.
PAGE 5-6. TERMINALS.

For price and delivery contact sales.

TEL:- (01782) 575316 FAX:- (01782) 834201 E-MAIL:- rseltd@btconnect.com

[Return to top](#)

R.S.ELECTRICAL (RSE) LTD.

SPECIALIST SUPPLIERS TO THE RAIL INDUSTRY.

ENTRELEC TERMINALS

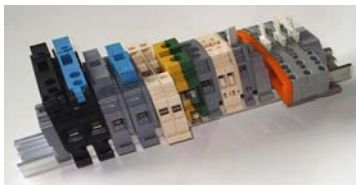

DIN RAILS

| BR.CAT.No. | RSE.CAT.No. | DESCRIPTION | |
|------------|-------------|--------------------------|--|
| 50/000309 | 17430017 | TOP HAT DIN RAIL | |
| 86/042091 | 17322005 | TOP HAT RAIL PRE-PUNCHED | |
| | 16305004 | G TYPE DIN RAIL | |

END STOPS AND MARKER HOLDERS

| BR.CAT.No. | RSE.CAT.No. | DESCRIPTION | |
|------------|-------------|----------------------------|--|
| 50/000308 | 10300226 | UNIVERSAL END STOP | |
| | 11308401 | MARKER HOLDER FOR END STOP | |
| | 11483600 | HIGH END STOP | |
| 86/042090 | 19930603 | BEIGE UNIVERSAL END STOP | |

JUMPER BARS

| BR.CAT.No. | RSE.CAT.No. | DESCRIPTION | |
|------------|-------------|-----------------------------------|--|
| 86/042106 | 16851625 | M4/6 2 POLE PRE-ASS.JUMPER BAR | |
| 86/042107 | 16851726 | M4/6 3 POLE PRE-ASS. JUMPER BAR | |
| 86/042108 | 16851807 | M4/6 4 POLE PRE-ASS.JUMPER BAR | |
| 86/042109 | 16851900 | M4/6 5 POLE PRE-ASS.JUMPER BAR | |
| 86/042110 | 16897307 | M4/6 10 POLE PRE-ASS.JUMPER BAR | |
| 86/042111 | 16852005 | M6/8 2 POLE PRE-ASS.JUMPER BAR | |
| 86/042112 | 16852122 | M6/8 3 POLE PRE-ASS.JUMPER BAR | |
| 86/042113 | 16852223 | M6/8 4 POLE PRE-ASS.JUMPER BAR | |
| 86/042114 | 16852324 | M6/8 5 POLE PRE-ASS.JUMPER BAR | |
| 86/042115 | 16897400 | M6/8 10 POLE PRE-ASS.JUMPER BAR | |
| | | | |
| 50/000338 | 17351020 | COMB JUMPER BAR | |
| 86/042116 | 17361121 | 2 POLE JUMPER BAR | |
| 86/042117 | 17361222 | 3 POLE JUMPER BAR | |
| 86/042118 | 17361323 | 4 POLE JUMPER BAR | |
| 86/042119 | 17361424 | 5 POLE JUMPER BAR | |
| 86/042120 | 17361525 | 10 POLE JUMPER BAR | |
| 86/042094 | 17599111 | 10P JB (NOT PRE-ASSEMBLED) | |
| 50/000307 | 17667910 | 10 POLE IP20 JUMPER BAR | |
| | 17765400 | 20 POLE J-BAR (NOT PRE-ASSEMBLED) | |
| 86/042095 | 16339426 | SCREWS FOR JUMPER BAR | |
| | 16860416 | POST SCREW AND WASHER | |
| 86/042096 | 16878301 | WASHERS FOR JUMPER BAR | |

For price and delivery contact sales.

TEL:- (01782) 575316 FAX:- (01782) 834201 E-MAIL:- rseltd@btconnect.com

R.S.ELECTRICAL (RSE) LTD.

SPECIALIST SUPPLIERS TO THE RAIL INDUSTRY.

ENTRELEC TERMINALS

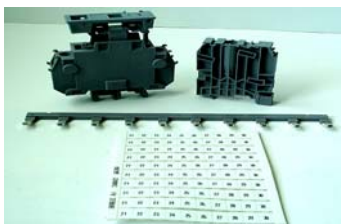

EARTH TERMINALS

| BR.CAT.No. | RSE.CAT.No. | DESCRIPTION | |
|------------|-------------|---------------------------|-----------------|
| | 16548827 | MA2.5/5.P 2.5mm | EARTH TERMINALS |
| | 16511316 | MA4/6.P 4mm | EARTH TERMINALS |
| | 16511417 | M6/8.P 6mm | EARTH TERMINALS |
| | 10306221 | YELLOW END PLATES TO SUIT | |
| | 19548816 | MA2.5/5.P VO 2.5mm | EARTH TERM. |
| 86/042073 | 19511305 | MA4/6.P VO 4mm | EARTH TERMINALS |
| 86/042074 | 19511406 | M6/8.P VO 6mm | EARTH TERMINALS |
| | 19930502 | YELLOW END PLATES TO SUIT | |
| | 16511510 | M10/10.P 10mm | EARTH TERMINALS |
| | 19511507 | M10/10.P VO 10mm | EARTH TERMINALS |
| | 16513023 | M12/12.P 12mm | EARTH TERMINALS |
| | 19513012 | M12/12.P VO 12m | EARTH TERMINALS |
| | 16511114 | M35/16.P 35mm | EARTH TERMINALS |
| | 19511103 | MM16/16.P VO 16mm | EARTH TERMINALS |

GREY TERMINALS

| BR.CAT.No. | RSE.CAT.No. | DESCRIPTION | |
|------------|-------------|----------------------------------|--|
| | 11548603 | 2.5mm GREY TERMINALS | |
| 86/042097 | 11511607 | 4mm GREY TERMINALS | |
| 86/042098 | 11511811 | 6mm GREY TERMINALS | |
| 86/042099 | 11512017 | 10mm GREY TERMINAL | |
| 86/042100 | 11836816 | GREY END PLATE | |
| 86/042101 | 11512914 | 16mm GREY TERMINALS | |
| 86/042102 | 11861801 | M16 GREY END PLATES | |
| | 11527122 | M4/6 D2 DOUBLE DECKER TERMINAL | |
| | 11849923 | M4 DOUBLE DECKER END PLATE | |
| | 11523710 | M6/8.ST1 TERM.BLOCK,TEST CIRCUIT | |
| | 11362927 | M6/8 END PLATE | |

FUSE HOLDERS

| BR.CAT.No. | RSE.CAT.No. | DESCRIPTION | |
|------------|-------------|----------------------------------|--|
| | 11537724 | ML 10/16.SF GREY FUSE HOLDER | |
| 86/042103 | 11565725 | M4/8.SF 4mm FUSED TERMINAL | |
| | 11695115 | M4 FUSE HOLDER END PLATE | |
| 86/042085 | 19565726 | M4/8.SF 4mm FUSED TERMINAL | |
| 86/042086 | 19695116 | M4/8.SF 4mm FUSED TERM.END PLATE | |
| 86/042087 | 19909513 | ML10/13.SF BLACK FUSE HOLDER | |
| 86/042089 | 19963524 | ML10/13 BLACK END PLATE | |

For price and delivery contact sales.

TEL:- (01782) 575316 FAX:- (01782) 834201 E-MAIL:- rseltd@btconnect.com

R.S.ELECTRICAL (RSE) LTD.

SPECIALIST SUPPLIERS TO THE RAIL INDUSTRY.

ENTRELEC TERMINALS

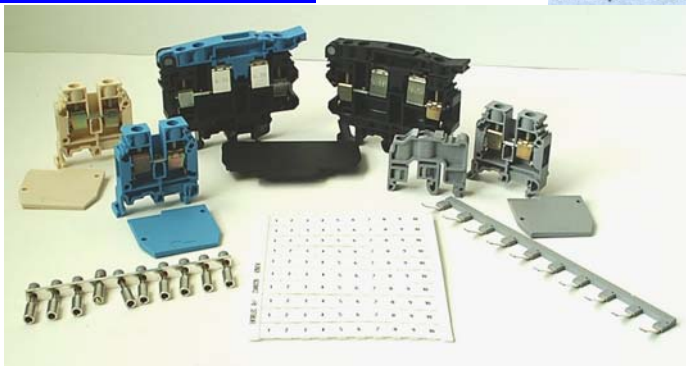

MISC. TERMINALS

| BR.CAT.No. | RSE.CAT.No. | DESCRIPTION | |
|------------|-------------|----------------------------------|--|
| 86/042076 | 11522921 | M4/6 SNTS DISCONNECT TERMINAL | |
| | 11537906 | ML 10/16.SN BLUE NEGATIVE HOLDER | |
| 86/042088 | 19910522 | ML10/13.SN BLUE NEGATIVE HOLDER | |
| | 12512011 | 10mm BLUE TERMINAL | |
| | 12836810 | 10mm BLUE END PLATE | |
| | 16326201 | TEST PLUG | |

BEIGE TERMINALS

| BR.CAT.No. | RSE.CAT.No. | DESCRIPTION | |
|------------|-------------|----------------------------------|--|
| | 19548604 | 2.5mm BEIGE TERMINAL | |
| 86/042070 | 19511600 | 4mm BEIGE TERMINAL | |
| 86/042071 | 19511812 | 6mm BEIGE TERMINAL | |
| 86/042072 | 19512010 | 10mm BEIGE TERMINAL | |
| | 19836817 | 10mm BEIGE END PLATE | |
| 86/042076 | 11522920 | M4/6 SNTS DISCONNECT TERMINAL | |
| 86/042077 | 118-368-16 | M4/6 SNTS DISCON. TERM.END PLATE | |
| 86/042078 | 19226227 | 71 LTW BEIGE VO TERMINAL | |
| 86/042079 | 19776625 | 71 LTW BEIGE VO TERM.END PLATE | |
| 86/042080 | 19568513 | M6/8 6mm SAFETY CON.BLOCK | |
| | 19698703 | M6/8 6mm SAFETY END PLATE | |
| 86/042082 | 19523610 | M6/8.ST TERM. BLOCK,TEST CIRCUIT | |
| | 19697922 | M6/8.ST TERM. BLOCK,END PLATE | |
| 86/042083 | 19524327 | M6/8 ST7 6mm WITH COMP.CLAMP | |
| 86/042084 | 19362920 | M6/8 ST7 6mm END PLATE | |
| | 19527123 | M4/6.D2 4mm D/D TERMINAL | |
| | 19849924 | M4/6.D2 4mm D/D TERM.END PLATE | |
| 86/042090 | 19930603 | BEIGE UNIVERSAL END STOP | |

For price and delivery contact sales.

TEL:- (01782) 575316 FAX:- (01782) 834201 E-MAIL:- rseltd@btconnect.com

R.S.ELECTRICAL (RSE) LTD.

SPECIALIST SUPPLIERS TO THE RAIL INDUSTRY.



MARKER CARDS

ENTRELEC TERMINALS

| BR.CAT.No. | RSE.CAT.No. | DESCRIPTION | |
|------------|-------------|--------------------------------|--|
| | 23100007 | RC510 BLANK MARKER | |
| | 23100225 | RC510 1-10 HORIZ. MARKER | |
| | 23100326 | RC510 11-20 HORIZ.MARKER | |
| | 23103024 | RC510 1-100 HORIZ.MARKER | |
| | 23106002 | RC510 1-100 VERT. MARKER | |
| | 23115421 | RC510 HORIZ.'E' MARKER CARD | |
| | 23116120 | RC510 HORIZ.'L' MARKER CARD | |
| | 23116322 | RC510 HORIZ.'N' MARKER | |
| | 23200000 | RC65 BLANK MARKER CARD | |
| | 23200225 | RC65 0-9 HORIZONTAL MARKER | |
| | 23200226 | RC65 1-10 HORIZONTAL MARKER | |
| | 23200327 | RC65 11-20 HORIZONTAL MARKER | |
| | 23200420 | RC65 21-30 HORIZONTAL MARKER | |
| | 23200521 | RC65 31-40 HORIZONTAL MARKER | |
| | 23203025 | RC65 1-100 HORIZONTAL MARKER | |
| | 23206003 | RC65 1-100 VERTICAL MARKER | |
| 86/042092 | 23300001 | RC610 BLANK MARKER CARD | |
| | 23300126 | RC610 0-9 HORIZONTAL MARKER | |
| | 23300227 | RC610 1-10 HORIZONTAL MARKER | |
| | 23300320 | RC610 11-20 HORIZONTAL MARKER | |
| | 23300421 | RC610 21-30 HORIZONTAL MARKER | |
| | 23300522 | RC610 31-40 HORIZONTAL MARKER | |
| | 23300623 | RC610 41-50 HORIZONTAL MARKER | |
| | 23303026 | RC610 1-100 HORIZONTAL MARKER | |
| | 23320204 | RC610 HORIZONTAL '1' MARKER | |
| | 23320205 | RC610 HORIZONTAL '2' MARKER | |
| | 23320206 | RC610 HORIZONTAL '3' MARKER | |
| | 23320207 | RC610 HORIZONTAL '4' MARKER | |
| | 23320600 | RC610 HORIZONTAL '5' MARKER | |
| | 23320701 | RC610 HORIZONTAL '6,9' MARKER | |
| | 23400002 | RC810 BLANK MARKER CARD | |
| 50/000310 | 23400220 | RC810 1-10 HORIZ. MARKER CARD | |
| 50/000357 | 23400321 | RC810 11-20 HORIZ. MARKER CARD | |
| | 23400422 | RC810 21-30 HORIZ. MARKER CARD | |
| | 23400523 | RC810 31-40 HORIZ. MARKER CARD | |
| | 23400624 | RC810 41-50 HORIZ. MARKER CARD | |
| | 23400725 | RC810 51-60 HORIZ. MARKER CARD | |
| | 23400806 | RC810 61-70 HORIZ. MARKER CARD | |
| | 23400907 | RC810 71-80 HORIZ. MARKER CARD | |
| | 23401023 | RC810 81-90 HORIZ. MARKER CARD | |
| | 23404126 | RC810 1-10 VERT. MARKER CARD | |
| | 23404227 | RC810 11-20 VERT. MARKER CARD | |
| | 23404320 | RC810 21-30 VERT. MARKER CARD | |

For price and delivery contact sales.

TEL:- (01782) 575316 FAX:- (01782) 834201 E-MAIL:- rseltd@btconnect.com

R.S.ELECTRICAL (RSE) LTD.

SPECIALIST SUPPLIERS TO THE RAIL INDUSTRY.

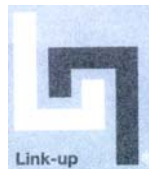

TERMINALS

| BR.CAT.No. | RSE.CAT.No. | DESCRIPTION | |
|------------|-----------------|------------------------------------|--|
| 86/042121 | WAGO280-675 | TERMINAL BLOCK | |
| 86/042124 | WAGO280-325 | GREY END PLATE | |
| 86/042125 | WAGO280-333 | ORANGE END PLATE | |
| 86/042126 | WAGO249-117 | END STOP | |
| 86/042122 | WAGO280-495 | DISCONNECT JUMPER LINK | |
| 86/042123 | WAGO280-498 | INSULATION STOP | |
| 86/042127 | WAGO126/011-000 | TEST PROBE | |
| | WAGO210-258 | SHORT ANGLED SCREWDRIVER | |
| | WAGO210-112 | SLOTTED DIN RAIL | |
| | WAGO777-310 | UNIVERSAL TOOL | |
| | WAGO280-432 | COMP.TOOL | |
| | WAGO206-101 | STRIPPING AND CUTTING TOOL | |
| | WAGO209-112 | GROUP MARKER CARRIER | |
| | WAGO209-666 | MARKER CARD 1-50 | |
| | WAGO209-607 | MARKER CARD 51-100 | |
| | WAGO209-608 | MARKER CARD 101-150 | |
| | WAGO209-113 | SELF MARKING MARKER CARD 100/SHT | |
| | WAGO210-113 | UNSLOTTED DIN RAIL (TS35) 35x7.5mm | |
| | WAGO210114 | UNSLOTTED DIN RAIL (TS35) 35x15mm | |
| | WAGO209-114 | TRANSPARENT PROTECTIVE COVER | |

For price and delivery contact sales.

TEL:- (01782) 575316 FAX:- (01782) 834201 E-MAIL:- rseltd@btconnect.com

R.S.ELECTRICAL (RSE) LTD.

SPECIALIST SUPPLIERS TO THE RAIL INDUSTRY.

RAIL ASSEMBLIES



| BR.CAT.No. | RSE.CAT.No. | DESCRIPTION | |
|------------|-------------|-------------------|--|
| | WAGOW37 | 37 WAY ONLY | |
| | WAGOW376 | 37 WAY AND 6 WAY | |
| | WAGOW379 | 37 WAY AND 9 WAY | |
| | WAGOW3710 | 37 WAY AND 10 WAY | |
| | WAGOW3711 | 37 WAY AND 11 WAY | |
| | WAGOW3715 | 37 WAY AND 15 WAY | |
| | WAGOW3717 | 37 WAY AND 17 WAY | |
| | WAGOW3719 | 37 WAY AND 19 WAY | |
| | WAGOW3722 | 37 WAY AND 22 WAY | |
| | WAGO3737 | 37 WAY AND 37 WAY | |
| | WAGOW27 | 27 WAY ONLY | |
| | WAGOW279 | 27 WAY AND 9 WAY | |
| | WAGOW2710 | 27 WAY AND 10 WAY | |
| | WAGO 2715 | 27 WAY AND 15 WAY | |
| | WAGO2721 | 27 WAY AND 21 WAY | |
| | WAGOW2728 | 27 WAY AND 28 WAY | |
| | WAGOW9 | 9 WAY ONLY | |
| | WAGOW12 | 12 WAY ONLY | |
| | WAGOW14 | 14 WAY ONLY | |
| | WAGOW17 | 17 WAY ONLY | |
| | WAGOW20 | 20 WAY ONLY | |
| | WAGOW22 | 22 WAY ONLY | |
| | WAGOW28 | 28 WAY ONLY | |

* SEE PREVIOUS PAGE FOR ACCESSORIES.
OTHER COMBINATIONS AVAILABLE ON REQUEST.

For price and delivery contact sales.

TEL:- (01782) 575316 FAX:- (01782) 834201 E-MAIL:-rseltd@btconnect.com

R.S.ELECTRICAL (RSE) LTD.

SPECIALIST SUPPLIERS TO THE RAIL INDUSTRY.



SECTION 3

FUSES AND FUSE HOLDERS

BUSSMANN

BUSSMANN FUSES AND FUSEHOLDERS ARE AN INTEGRAL PART OF LOCATION CASE MAKE UP. WE CARRY LARGE STOCKS ENABLING US TO GIVE YOU SAME DAY OR NEXT DAY DELIVERY.

WE ALSO CARRY STOCK OF THE GEC RANGE OF FUSEHOLDERS AND LINKS.

PAGE 1. BUSSMAN FUSE HOLDERS AND FUSELINKS.
PAGE 2. ENTRELEC TERMINAL FUSELINKS.

For price and delivery contact sales.

TEL:- (01782) 575316 FAX:- (01782) 834201 E-MAIL:-rseltd@btconnect.com

[Return to top](#)

R.S.ELECTRICAL (RSE) LTD.

SPECIALIST SUPPLIERS TO THE RAIL INDUSTRY.



BUSSMAN FUSE HOLDERS & LINKS

| BR.CAT.No. | RSE.CAT.No. | DESCRIPTION | |
|------------|------------------|--------------------------------|--|
| 86/013053 | BUSSCM32F/B | 32A BLACK FUSE HOLDER | |
| 86/013054 | BUSSCM63F/B | 63A BLACK FUSE HOLDER | |
| 86/013055 | BUSSCM100F/B | 100A BLACK FUSE HOLDER | |
| | BUSSCM32F/W | 32A WHITE FUSE HOLDER | |
| | BUSSCM63F/W | 63A WHITE FUSE HOLDER | |
| | BUSSCM100F/W | 100A WHITE FUSE HOLDER | |
| | BUSSCM32F/G | 32A GREY FUSE HOLDER | |
| 86/013065 | BUSS32CML | 32A NEUTRAL LINK | |
| 86/013056 | BUSS63/100CML | 63/100A NEUTRAL LINK | |
| 86/013057 | BUSS32BS | 32A BACK STUD | |
| 86/013058 | BUSS63/100BS | 63/100A BACK STUD | |
| 86/013059 | BUSS32SLC | 32A LOCKING SAFETY CARRIER | |
| 86/013064 | BUSS63/100SLC | 63/100A LOCKING SAFETY CARRIER | |
| 54/106550 | BUSSHO72(T1A2) | 2A 660V FUSE LINK | |
| 54/106552 | BUSSHO74(T1A4) | 4A 660V FUSE LINK | |
| 54/106554 | BUSSHO76(T1A6) | 6A 660V FUSE LINK | |
| 54/106556 | BUSSHO710(T1A10) | 10A 660V FUSE LINK | |
| 54/106558 | BUSSHO716(T1A16) | 16A 660V FUSE LINK | |
| 54/106560 | BUSSHO720(T1A20) | 20A 660V FUSE LINK | |
| 54/106562 | BUSSHO725(T1A25) | 25A 660V FUSE LINK | |
| 54/106564 | BUSSHO732(T1A32) | 32A 660V FUSE LINK | |
| 54/106810 | BUSS54/106810 | 14x51mm BLACK 3A FUSE | |
| 54/106812 | BUSS54/106812 | 14x51mm WHITE 5A FUSE | |
| 54/106814 | BUSS54/106814 | 14x51mm GREEN 10A FUSE | |
| 54/106816 | BUSS54/106816 | 14x51mm BLUE 15A FUSE | |
| 54/106818 | BUSS54/106818 | 14x51mm YELLOW 20A FUSE | |

| BR.CAT.No. | RSE.CAT.No. | DESCRIPTION | |
|------------|-------------|-------------------|--|
| | N/S32CML | 32A COPPER LINK | |
| | N/S 63CML | 63A COPPER LINKS | |
| | N/S 100CML | 100A COPPER LINKS | |

For price and delivery contact sales.

TEL:- (01782) 575316 FAX:- (01782) 834201 E-MAIL:- rseltd@btconnect.com

R.S.ELECTRICAL (RSE) LTD.

SPECIALIST SUPPLIERS TO THE RAIL INDUSTRY.



ENTRELEC TERMINAL FUSELINKS

| <u>BR.CAT.No.</u> | <u>RSE.CAT.No.</u> | <u>DESCRIPTION</u> | |
|-------------------|--------------------|---------------------------|--|
| | FUSE314/001 | 1A FUSE | |
| | FUSE314/002 | 2A FUSE | |
| | FUSE314/003 | 3A FUSE | |
| | FUSE314/004 | 4A FUSE | |
| | FUSE314/005 | 5A FUSE | |
| | FUSE314/010 | 10A FUSE | |
| | FUSE314/15 | 15A FUSE | |
| | FUSE314/020 | 20A FUSE | |
| | N.S.43100N | NEUTRAL NINK FOR 11630223 | |
| | ENTREL17358215 | NEUTRAL LINK FOR 11537724 | |

For price and delivery contact sales.

TEL:- (01782) 575316 FAX:- (01782) 834201 E-MAIL:-rseltd@btconnect.com

R.S.ELECTRICAL (RSE) LTD.

SPECIALIST SUPPLIERS TO THE RAIL INDUSTRY.



SECTION 4

POWER ENCLOSURES

ABB

CSE POWER

BOX

BOMBARDIER

THIS SECTION ILLUSTRATES THE VAST RANGE OF POWER SWITCHING AVAILABLE FROM ABB WHICH WE KEEP IN STOCK TO THE SIG TYPE AND BOMBARDIER SWITCHES WHICH WE CAN SUPPLY TO ORDER. WE CAN ALSO OFFER YOU MODIFICATION OF ABB SWITCHES TO SUIT YOUR NEEDS EG. COMBINATION SWITCHES ETC..

| | |
|---------|--|
| PAGE 1. | ABB ENCLOSED SWITCHES, SPREADER BOXES. |
| PAGE 2. | SIG1-10 POWER BOXES. |
| PAGE 3. | BOMBARDIER POWER ENCLOSURES. |

For price and delivery contact sales.

TEL:- (01782) 575316 FAX:- (01782) 834201 E-MAIL:-rseltd@btconnect.com

[Return to top](#)

R.S.ELECTRICAL (RSE) LTD.

SPECIALIST SUPPLIERS TO THE RAIL INDUSTRY.



ABB. ENCLOSED SWITCHES

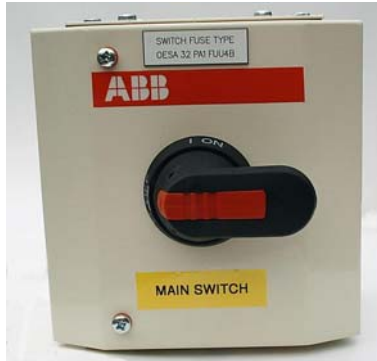

| BR.CAT.No. | RSE.CAT.No. | DESCRIPTION | |
|--------------|----------------|------------------------------|--|
| BR.54/064060 | OESA32PA1FUU3B | 32A 3 POLE 690V SWITCH FUSE | |
| BR.54/064061 | OESAGA3F | 63A 3 POLE 690V SWITCH FUSE | |
| BR.54/064062 | OESA100GA3F | 100A 3 POLE 690V SWITCH FUSE | |
| BR.54/064063 | OESA32PA1FUU4B | 32A 4 POLE 690V SWITCH FUSE | |
| BR.54/064064 | OESA63GA4F | 63A 4 POLE 690V SWITCH FUSE | |
| BR.54/064065 | OESA100GA4F | 100A 4 POLE 690V SWITCH FUSE | |

SPREADER BOX

| BR.CAT.No. | RSE.CAT.No. | DESCRIPTION | |
|--------------|-------------|--------------------------------------|--|
| BR.54/001357 | SB SIZE 1 | FOR TERMINATION OF LARGE CABLES 95mm | |

For price and delivery contact sales.

TEL:- (01782) 575316 FAX:- (01782) 834201 E-MAIL:- rseltd@btconnect.com

R.S.ELECTRICAL (RSE) LTD.

SPECIALIST SUPPLIERS TO THE RAIL INDUSTRY.



CSE POWERBOX SIG TYPE SWITCHES



| BR.CAT.No | RSE.CAT.No. | DESCRIPTION | |
|--------------|-------------|---|--|
| BR.54/003901 | SIG1 | SINGLE SWITCH HALF SIZE | |
| BR.54/003902 | SIG2 | TWO SWITCHES HALF SIZE | |
| BR.54/003903 | SIG3 | FULL SIZE INTERMEDIATE SWITCHING GROUPED TRANSFORMER ISOLATION | |
| BR.54/003904 | SIG4 | FULL SIZE INTERMEDIATE SWITCHING GROUPED TRANSFORMER ISOLATION SECONDARY SUPPLY | |
| BR.54/003905 | SIG5 | FULL SIZE INTERMEDIATE SWITCHING INDIVIDUAL TRANSFORMER ISOLATION | |
| BR.54/003906 | SIG6 | FULL SIZE 3 PHASE INTERMEDIATE SWITCHING GROUPED TRANSFORMER ISOLATION | |
| BR.54/003907 | SIG7 | FULL SIZE MULTI-SUPPLY INTERMEDIATE SWITCHING GROUPED TRANSFORMER ISOLATION | |
| BR.54/003908 | SIG8 | FULL SIZE INTERMEDIATE SWITCHING GROUPED TRANSFORMER ISOLATION IP65 RATED | |
| BR.54/003909 | SIG9 | FULL SIZE DUAL SUPPLY GROUPED TRANSFORMER ISOLATION IP65 RATED | |
| BR.54/003910 | SIG10 | 316 STAINLESS STEEL FUSES PRE-WIRED TO TERMINALS, PADLOCKABLE FRONT PANEL POWER ON/OFF TEST POINTS. | |

MODIFICATIONS AVAILABLE UPON REQUEST.

For price and delivery contact sales.

TEL:- (01782) 575316 FAX:- (01782) 834201 E-MAIL:- rseltd@btconnect.com

R.S.ELECTRICAL (RSE) LTD.

SPECIALIST SUPPLIERS TO THE RAIL INDUSTRY.

BOMBARDIER POWER ENCLOSURES



| BR.CAT.No | RSE.CAT.No. | DESCRIPTION | |
|--------------|-----------------|---------------------------|--|
| BR.86/010001 | 36/5/119162GA3L | 650V 4 SWITCH 4 FUSE | |
| BR.86/010002 | 36/5/119233GA3L | 650V 3SWITCH 4 FUSE | |
| BR.86/010003 | 36/5/119236GA3L | 650V 1 SWITCH 4 FUSE | |
| BR.86/010004 | 36/5/119239GA3L | 650V 4 SWITCH 8 FUSE | |
| BR.86/010005 | 36/5/119242GA3L | 650V 2 SWITCH 8 FUSE | |
| BR.86/010006 | 36/5/122444GA3L | 650V 4 SWITCH 4 FUSE MCB. | |

For price and delivery contact sales.

TEL:- (01782) 575316 FAX:- (01782) 834201 E-MAIL:-rseltd@btconnect.com

R.S.ELECTRICAL (RSE) LTD.

SPECIALIST SUPPLIERS TO THE RAIL INDUSTRY.



SECTION 5 **ENCLOSURES**

ABB

THIS SECTION COVERS STEEL AND STAINLESS STEEL ENCLOSURES USED IN RAILWAYS, WE CAN ALSO SUPPLY BOTH PLASTIC AND ZERO HALOGEN ENCLOSURES. OTHER MANUFACTURERS IN THIS RANGE INCLUDE ABB AND FIBOX. CONTACT US FOR DETAILS.

PAGE 1-2.

ST BOXES.

PAGE 2.

STAINLESS STEEL ENCLOSURES.

For price and delivery contact sales.

TEL:- (01782) 575316 FAX:- (01782) 834201 E-MAIL:-rseltd@btconnect.com

[Return to top](#)

R.S.ELECTRICAL (RSE) LTD.

SPECIALIST SUPPLIERS TO THE RAIL INDUSTRY.

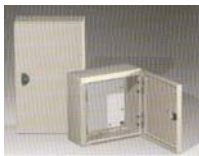

ENCLOSURES

ST Boxes with Blank Door

| BR.CAT.No. | RSE.CAT.No. | DESCRIPTION | |
|------------|--------------|------------------------|--|
| | ETA ST2/315 | 200x300x150 ENCLOSURE | |
| | ETA ST3/315 | 300x300x150 ENCLOSURE | |
| | ETA ST3/415 | 300x400x150 ENCLOSURE | |
| | ETA ST3/515 | 300x500x150 ENCLOSURE | |
| | ETA ST4/315 | 400x300x150 ENCLOSURE | |
| | | | |
| | ETA ST3/420 | 300x400x200 ENCLOSURE | |
| | ETA ST3/520 | 300x500x200 ENCLOSURE | |
| | ETA ST4/320 | 400x300x200 ENCLOSURE | |
| | ETA ST4/420 | 400x400x200 ENCLOSURE | |
| | ETA ST4/520 | 400x500x200 ENCLOSURE | |
| | ETA ST4/620 | 400x600x200 ENCLOSURE | |
| | | | |
| | ETA ST5/520 | 500x500x200 ENCLOSURE | |
| | ETA ST5/720 | 500x700x200 ENCLOSURE | |
| | | | |
| | ETA ST6/420 | 600x400x200 ENCLOSURE | |
| | ETA ST6/620 | 600x600x200 ENCLOSURE | |
| | ETA ST6/820 | 600x800x200 ENCLOSURE | |
| | | | |
| | ETA ST4/525 | 400x500x250 ENCLOSURE | |
| | ETA ST4/625 | 400x600x250 ENCLOSURE | |
| | ETA ST5/725 | 500x700x250 ENCLOSURE | |
| | ETA ST6/825 | 600x800x250 ENCLOSURE | |
| | ETA ST6/1025 | 600x1000x250 ENCLOSURE | |
| | | | |
| | ETA ST6/430 | 600x400x300 ENCLOSURE | |
| | ETA ST6/630 | 600x600x300 ENCLOSURE | |
| | ETA ST6/830 | 600x800x300 ENCLOSURE | |
| | ETA ST6/1030 | 600x1000x300 ENCLOSURE | |
| | ETA ST6/1230 | 600x1200x300 ENCLOSURE | |
| | ETA ST8/830 | 800x800x300 ENCLOSURE | |
| | ETAST8/1030 | 800x1000x300 ENCLOSURE | |
| | ETA ST8/1230 | 800x1200x300 ENCLOSURE | |
| | | | |
| | ETA ST4/640 | 400x600x400 ENCLOSURE | |
| | ETA ST6/640 | 600x600x400 ENCLOSURE | |
| | ETA ST6/840 | 600x800x400 ENCLOSURE | |
| | ETA ST6/1040 | 600x1000x400 ENCLOSURE | |
| | ETA ST8/840 | 800x800x400 ENCLOSURE | |
| | ETA ST8/1040 | 800x1000x400 ENCLOSURE | |

For price and delivery contact sales.

TEL:- (01782) 575316 FAX:- (01782) 834201 E-MAIL:- rseltd@btconnect.com

R.S.ELECTRICAL (RSE) LTD.

SPECIALIST SUPPLIERS TO THE RAIL INDUSTRY.



ENCLOSURES



ST Boxes with Double Door

| BR.CAT.No. | RSE.CAT.No. | DESCRIPTION | |
|------------|---------------|-------------------------|--|
| | ETA ST8/630 | 800x600x300 ENCLOSURE | |
| | ETA ST10/820 | 1000x800x200 ENCLOSURE | |
| | ETA ST10/830 | 1000x800x300 ENCLOSURE | |
| | ETA ST10/1030 | 1000x1000x300 ENCLOSURE | |
| | ETA ST10/1230 | 1000x1200x300 ENCLOSURE | |



STX Stainless Steel Boxes.

| BR.CAT.No. | RSE.CAT.No. | DESCRIPTION | |
|------------|---------------|------------------------|--|
| | ETA STX2/315 | 200x300x150 ENCLOSURE | |
| | ETA STX3/415 | 300x400x150 ENCLOSURE | |
| | ETA STX3/420 | 300x400x200 ENCLOSURE | |
| | ETA STX4/315 | 400x300x150 ENCLOSURE | |
| | ETA STX4/420 | 400x400x200 ENCLOSURE | |
| | ETA STX4/620 | 400x600x200 ENCLOSURE | |
| | ETA STX5/520 | 500x500x200 ENCLOSURE | |
| | ETA STX6/620 | 600x600x200 ENCLOSURE | |
| | ETA STX6/625 | 600x600x250 ENCLOSURE | |
| | ETA STX6/820 | 600x800x200 ENCLOSURE | |
| | ETA STX6/825 | 600x800x250 ENCLOSURE | |
| | ETA STX8/830 | 800x800x300 ENCLOSURE | |
| | ETA STX8/1030 | 800x1000x300 ENCLOSURE | |

For price and delivery contact sales.

TEL:- (01782) 575316 FAX:- (01782) 834201 E-MAIL:- rseltd@btconnect.com



SECTION 6

CABLE

IN THIS SECTION WE SHOW OUR FULL RANGE OF CABLES, FROM TRI-RATED THROUGH TO SIGNALLING, COMMUNICATION AND POWER CABLES. WE CARRY STOCKS OF MANY OF THE CABLES ILLUSTRATED, AND CAN OFFER NEXT DAY DELIVERY TO SITE, IF REQUIRED, DIRECT FROM THE MANUFACTURER. WE ALSO SPECIALIZE IN ZERO HALOGEN CABLES USED IN ENCLOSED AREAS, SUCH AS RAILWAY STATIONS, HAVING SUPPLIED ALL THE CABLE ON THE RECENT BIRMINGHAM NEW STREET RE- SIGNALLING PROJECT.

- PAGE 1. 6491B,6491X, TRI-RATED AND TYPE 3 SIGNALLING CABLES
- PAGE 2. A1,A2 AND A3 RAILWAY SIGNALLING CABLE.
- PAGE 3-4. B1 AND B2 LINESIDE CABLING.
- PAGE 5. C1,C2 AND C3 TYPE CABLES.
- PAGE 6. TYPE D1 AND D2 CABLES.
- PAGE 7. TYPE E1,E2 AND E3 CABLES.
- PAGE 8. TRACK FEEDER CABLES,POWER CABLES,CABLE CLEANERS.

DUE TO THE FLUCTUATION OF COST OF BASE METALS PRICES MAY VARY.
PLEASE REQUEST PRICE BEFORE ORDERING.

For price and delivery contact sales.

TEL:- (01782) 575316 FAX:- (01782) 834201 E-MAIL:-rseltd@btconnect.com

R.S.ELECTRICAL (RSE) LTD.

SPECIALIST SUPPLIERS TO THE RAIL INDUSTRY.

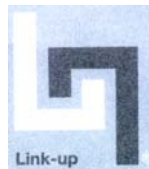

CABLE

Larger Sizes Available
Prices On Request



450/750V 6491X Cable * Specify Colour

| BR.CAT.No | RSE.CAT.No. | DESCRIPTION | |
|-----------|-------------|-----------------|--|
| | C6491X1.5* | 1.5mm STRANDED | |
| | C6491X2.5* | 2.5mm STRANDED | |
| | C6491X4.0* | 4.0mm STRANDED | |
| | C6491X6.0* | 6.0mm STRANDED | |
| | C6491X10.0* | 10.0mm STRANDED | |
| | C6491X16.0* | 16.0mm STRANDED | |
| | C6491X25.0* | 25.0mm STRANDED | |

600/1000V 6491B Cables * Specify Colour

| BR.CAT.No | RSE.CAT.No. | DESCRIPTION | |
|-----------|-------------|-----------------|--|
| | C6491B1.5* | 1.5mm STRANDED | |
| | C6491B2.5* | 2.5mm STRANDED | |
| | C6491B4.0* | 4.0mm STRANDED | |
| | C6491B6.0* | 6.0mm STRANDED | |
| | C6491B10.0* | 10.0mm STRANDED | |
| | C6491B16.0* | 16.0mm STRANDED | |
| | C6491B25.0* | 25.0mm STRANDED | |

600/1000V TRI-Rated Cables * Specify Colour

| BR.CAT.No | RSE.CAT.No. | DESCRIPTION | |
|-----------|-------------|------------------|--|
| | C0.5* | 0.5mm TRI-RATED | |
| | C0.75* | 0.75mm TRI-RATED | |
| | C1.0* | 1.0mm TRI-RATED | |
| | C1.5* | 1.5mm TRI-RATED | |
| | C2.5* | 2.5mm TRI-RATED | |
| | C4.0* | 4.0mm TRI-RATED | |
| | C6.0* | 6.0mm TRI-RATED | |
| | C10.0* | 10.0mm TRI-RATED | |
| | C16.0* | 16.0mm TRI-RATED | |
| | C25.0* | 25.0mm TRI-RATED | |
| | C35.0* | 35.0mm TRI-RATED | |

Type 3 Signalling LOC Cables

****Available in White Pink and Red**

| BR.CAT.No | RSE.CAT.No. | DESCRIPTION | |
|-----------|-------------|-------------------------|--|
| | 24/020** | 24 STRANDS OF 0.2 CABLE | |
| | 32/020** | 32 STRANDS OF 0.2 CABLE | |

For price and delivery contact sales.

TEL:- (01782) 575316 FAX:- (01782) 834201 E-MAIL:- rseltd@btconnect.com

R.S.ELECTRICAL (RSE) LTD.

SPECIALIST SUPPLIERS TO THE RAIL INDUSTRY.

Railway Signalling Cables



Type : A1 Internal wiring used in Relay Rooms and Equipment Housings.
650/1100V, Flame Retardant Halogen free insulation.
Railtrack specification RT/E/PS/00005

| Size mm ² | Cat. No. | Colour | Conductor class | Cable OD mm | Weight Kg/Km | Radial Thickness mm | |
|----------------------|------------|--------|-----------------|-------------|--------------|---------------------|--------|
| | | | | | | Insulation | sheath |
| 0.75 | 006/120001 | Blue | 2 | 3.0 | 18 | 0.85 | - |
| 0.75 | 006/120002 | Brown | 2 | 3.0 | 18 | 0.85 | - |
| 0.75 | 006/120003 | Red | 2 | 3.0 | 18 | 0.85 | - |
| 0.75 | 006/120004 | Orange | 2 | 3.0 | 18 | 0.85 | - |
| 0.75 | 006/120005 | Grey | 2 | 3.0 | 18 | 0.85 | - |
| 0.75 | 006/120006 | Violet | 2 | 3.0 | 18 | 0.85 | - |
| 0.75 | 006/120007 | Black | 2 | 3.0 | 18 | 0.85 | - |
| 1.15 | 006/120008 | Black | 2 | 3.0 | 22 | 0.85 | - |

Type : A2 Internal wiring used in Relay Rooms and Equipment Housings.
650/1100V, Flame Retardant Halogen free insulation.
Flame Retardant Halogen free Sheath.
Railtrack specification RT/E/PS/00005

| Size mm ² | Cat. No. | Conductor class | Cable OD mm | Weight Kg/Km | Radial Thickness mm | |
|----------------------|------------|-----------------|-------------|--------------|---------------------|--------|
| | | | | | Insulation | sheath |
| 0.75 | 006/120020 | 2 | 4.5 | 35 | 0.85 | 0.7 |
| 1.15 | 006/120024 | 2 | 4.8 | 40 | 0.85 | 0.7 |

Type : A3 Internal wiring used in Relay Rooms and Equipment Housings.
650/1100V, Flame Retardant Halogen free insulation.
Flame Retardant Halogen free Sheath.
Railtrack specification RT/E/PS/00005

| No.Cores/ Size mm ² | Cat. No. | Conductor class | Cable OD mm | Weight Kg/ Km | Radial Thickness mm | |
|-----------------------------------|------------|-----------------|-------------|------------------|---------------------|--------|
| | | | | | Insulation | sheath |
| 2 x 0.75 | 006/120040 | 2 | 7.8 | 89 | 0.85 | 0.9 |
| 4 x 0.75 | 006/120041 | 2 | 9.2 | 120 | 0.85 | 1.0 |
| 6 x 0.75 | 006/120042 | 2 | 11.2 | 178 | 0.85 | 1.1 |
| 10x0.75 | 006/120043 | 2 | 14.4 | 270 | 0.85 | 1.2 |
| 14x0.75 | 006/120044 | 2 | 17.7 | 495 | 0.85 | 1.3 |
| 36x0.75 | 006/120045 | 2 | 27.0 | 752 | 0.85 | 1.6 |
| 48x0.75 | 006/120046 | 2 | 31.0 | 963 | 0.85 | 1.6 |

For price and delivery contact sales.

TEL:- (01782) 575316 FAX:- (01782) 834201 E-MAIL:- rseltd@btconnect.com

R.S.ELECTRICAL (RSE) LTD.

SPECIALIST SUPPLIERS TO THE RAIL INDUSTRY.

Railway Signalling Cables



Type : B1 Single core Power & Lineside cabling.
650/1100V, EPR compound insulation, Heavy duty PCP sheath.
Railtrack specification RT/E/PS/00005

| No.Cores/ Size mm ² | Cat. No. | Conductor class | Cable OD mm | Weight Kg/ Km | Radial Thickness mm | | |
|-----------------------------------|------------|--------------------|----------------|------------------|---------------------|--------|--|
| | | | | | Insulation | sheath | |
| 1 x 2.5 | 006/120061 | 2 | 7.8 | 92 | 0.85 | 2.0 | |
| 1 x 10.0 | 006/120062 | 2 | 10.4 | 200 | 1.0 | 2.0 | |
| 1 x 35.0 | 006/120063 | 2 | 14.5 | 496 | 1.2 | 2.0 | |

Type : B2 Twin-core Power & Lineside cabling.
650/1100V, EPR compound insulation, Heavy duty PCP sheath.
Railtrack specification RT/E/PS/00005

| No.Cores/ Size mm ² | Cat. No. | Conductor class | Cable OD mm | Weight Kg/Km | Radial Thickness mm | | |
|-----------------------------------|------------|--------------------|----------------|-----------------|---------------------|--------|--|
| | | | | | Insulation | sheath | |
| 2 x 1.5 | 006/120081 | 2 | 10.2 | 92 | 0.8 | 2.0 | |
| 2 x 2.5 | 006/120082 | 2 | 11.4 | 200 | 0.8 | 2.0 | |
| 2 x 10.0 | 006/120083 | 2 | 16.5 | 496 | 1.0 | 2.0 | |
| 2 x 35.0 | 006/120084 | 2 | 24.0 | 1340 | 1.2 | 2.2 | |
| 2 x 70.0 | 006/120085 | 2 | 31.0 | 2200 | 1.4 | 2.4 | |
| 2 x 95.0 | 006/120086 | 2 | 36.0 | 3200 | 1.6 | 2.6 | |

Type : B2 Multi-core Power & Lineside cabling.
650/1100V, EPR compound insulation, Heavy duty PCP sheath.
Railtrack specification RT/E/PS/00005

| No.Cores/ Size mm ² | Cat. No. | Conductor class | Cable OD mm | Weight Kg/ Km | Radial Thickness mm | | |
|-----------------------------------|------------|--------------------|----------------|------------------|---------------------|--------|--|
| | | | | | Insulation | sheath | |
| 7 x 1.5 | 006/120091 | 2 | 14.0 | 300 | 0.8 | 2.0 | |
| 7 x 2.5 | 006/120092 | 2 | 15.0 | 381 | 0.8 | 2.0 | |
| | | | | | | | |
| 10x0.75 | 006/120093 | 2 | 15.2 | 310 | 0.85 | 2.0 | |
| 10 x 1.5 | 006/120094 | 2 | 17.0 | 400 | 0.8 | 2.0 | |
| 10 x 2.5 | 006/120095 | 2 | 18.5 | 528 | 0.8 | 2.0 | |

For price and delivery contact sales.

TEL:- (01782) 575316 FAX:- (01782) 834201 E-MAIL:- rseltd@btconnect.com

R.S.ELECTRICAL (RSE) LTD.

SPECIALIST SUPPLIERS TO THE RAIL INDUSTRY.

Railway Signalling Cables



Type : B2 Multi-core Power & Lineside cabling.
650/1100V, EPR compound insulation,
Heavy duty PCP sheath.
Railtrack specification RT/E/PS/00005

| No.Cores/ Size mm2 | Cat. No. | Conductor class | Cable OD mm | Weight Kg/Km | Radial Thickness mm Insulation | sheath | |
|-----------------------|------------|-----------------|----------------|-----------------|-----------------------------------|--------|--|
| 12x0.75 | 006/120096 | 2 | 16.0 | 325 | 0.85 | 2.0 | |
| 12 x 1.5 | 006/120097 | 2 | 17.5 | 455 | 0.8 | 2.0 | |
| 12 x 2.5 | 006/120098 | 2 | 19.3 | 577 | 0.8 | 2.0 | |
| | | | | | | | |
| 19x0.75 | 006/120099 | 2 | 18.3 | 460 | 0.85 | 2.0 | |
| 19 x 1.5 | 006/120100 | 2 | 20.2 | 655 | 0.8 | 2.0 | |
| 19 x 2.5 | 006/120101 | 2 | 22.3 | 865 | 0.8 | 2.0 | |
| | | | | | | | |
| 27x0.75 | 006/120102 | 2 | 21.5 | 620 | 0.85 | 2.0 | |
| 27 x 1.5 | 006/120103 | 2 | 24.5 | 930 | 0.8 | 2.2 | |
| 27 x 2.5 | 006/120104 | 2 | 27 | 1180 | 0.8 | 2.2 | |
| | | | | | | | |
| 37x0.75 | 006/120105 | 2 | 24.5 | 820 | 0.85 | 2.2 | |
| 37 x 1.5 | 006/120106 | 2 | 27.0 | 1170 | 0.8 | 2.2 | |
| 37 x 2.5 | 006/120107 | 2 | 30.4 | 1590 | 0.8 | 2.4 | |
| | | | | | | | |
| 48x0.75 | 006/120108 | 2 | 27.6 | 1022 | 0.85 | 2.2 | |
| 48 x 1.5 | 006/120109 | 2 | 31.0 | 1460 | 0.8 | 2.4 | |
| 48 x 2.5 | 006/120110 | 2 | 35.0 | 2020 | 0.8 | 2.6 | |

For price and delivery contact sales.

TEL:- (01782) 575316 FAX:- (01782) 834201 E-MAIL:- rseltd@btconnect.com

R.S.ELECTRICAL (RSE) LTD.

SPECIALIST SUPPLIERS TO THE RAIL INDUSTRY.

Railway Signalling Cables



Type : C1 Tail Cables for use in cross track situations.
650/1100V, Flexible Conductor, EPR Compound
insulation. Heavy Duty PCP Sheath.
Railtrack specification RT/E/PS/00005

| No.Cores/ Size mm2 | Cat. No. | Conductor class | Cable OD mm | Weight Kg/ Km | Radial Thickness mm | | |
|-----------------------|------------|--------------------|----------------|------------------|---------------------|--------|--|
| | | | | | Insulation | sheath | |
| 1 x 2.5 | 006/120130 | 5 | 12.0 | 178 | 1.05 | 3.8 | |

Type : C2 Tail Cables for use in cross track situations.
650/1100V, Flexible Conductor, EPR Compound insulation.
Heavy Duty PCP Sheath.
Railtrack specification RT/E/PS/00005

| No.Cores/ Size mm2 | Cat. No. | Conductor class | Cable OD mm | Weight Kg/Km | Radial Thickness mm | | |
|-----------------------|------------|-----------------|----------------|-----------------|---------------------|--------|--|
| | | | | | Insulation | sheath | |
| 2 x 2.5 | 006/120140 | 5 | 16.0 | 315 | 1.05 | 3.8 | |
| 4 x 2.5 | 006/120141 | 5 | 17.6 | 405 | 1.05 | 3.8 | |
| 7 x 2.5 | 006/120142 | 5 | 20.5 | 560 | 1.05 | 3.8 | |
| 10 x2.5 | 006/120143 | 5 | 24.5 | 740 | 1.05 | 3.8 | |
| 12 x2.5 | 006/120144 | 5 | 25.5 | 870 | 1.05 | 3.8 | |
| 16 x2.5 | 006/120145 | 5 | 27.9 | 948 | 1.05 | 3.8 | |

Type : C3 Screened Cable for use in T.P.W.S. installations.
650/1100V, Flexible Conductor, EPR Compound insulation.
Aluminium Tape Screen with Drain Wire, Heavy Duty PCP Sheath.
Railtrack specification RT/E/PS/00005

| No.Cores/ Size mm2 | Cat. No. | Conductor class | Cable OD mm | Weight Kg/Km | Radial Thickness mm | | |
|-----------------------|------------|-----------------|----------------|-----------------|---------------------|--------|--|
| | | | | | Insulation | sheath | |
| 1x2x2.5 | 006/160086 | 5 | 16.5 | 345 | 1.05 | 3.8 | |

For price and delivery contact sales.

TEL:- (01782) 575316 FAX:- (01782) 834201 E-MAIL:- rseltd@btconnect.com

R.S.ELECTRICAL (RSE) LTD.

SPECIALIST SUPPLIERS TO THE RAIL INDUSTRY.

Railway Signalling Cables



Type : D1 Tail Cables for use in cross track situations.
650/1100V, Flexible Conductor, EPR Compound
insulation. Heavy Duty PCP Sheath.
Railtrack specification RT/E/PS/00005

| No.Cores/ Size mm2 | Cat. No. | No. Of Cores | Radial Thickness mm sheath | Weight Kg/ Km | Cable OD Mm | | |
|-----------------------|------------|--------------|-------------------------------|------------------|-------------|------|--|
| | | | | | Min | Max | |
| 1 x 0.75 | 006/120211 | 1 | 2.0 | 25 | 6.5 | 8.1 | |
| 1 x 1.5 | 006/120212 | 1 | 2.0 | 30 | 6.8 | 8.5 | |
| 1 x 2.5 | 006/120213 | 1 | 2.0 | 34 | 7.2 | 8.9 | |
| 1 x 10 | 006/120214 | 1 | 2.0 | 205 | 9.4 | 11.8 | |
| 1 x 35 | 006/120215 | 1 | 2.0 | 495 | 12.9 | 16.1 | |

Type : D2 Tail Cables for use in cross track situations.
650/1100V, Flexible Conductor, EPR Compound insulation.
Heavy Duty PCP Sheath.
Railtrack specification RT/E/PS/00005

| No.Cores/ Size mm2 | Cat. No. | No. Of Cores | Radial Thickness mm sheath | Weight Kg/ Km | Cable OD Mm | | |
|-----------------------|------------|--------------|-------------------------------|------------------|-------------|------|--|
| | | | | | Min | Max | |
| 2 x 1.5 | 006/120216 | 2 | 2.0 | 25 | 6.5 | 8.1 | |
| 2 x 2.5 | 006/120217 | 2 | 2.0 | 30 | 6.8 | 8.5 | |
| 2 x 10 | 006/120218 | 2 | 2.0 | 34 | 7.2 | 8.9 | |
| 2 x 35 | 006/120219 | 2 | 2.0 | 205 | 9.4 | 11.8 | |
| 27 x 0.75 | 006/120238 | 27 | 2.0 | 606 | 20.1 | 25.1 | |
| 27 x 1.5 | 006/120239 | 27 | 2.2 | 897 | 22.2 | 27.8 | |
| 37 x 0.75 | 006/120241 | 37 | 2.2 | 786 | 22.7 | 28.4 | |
| 37 x 1.5 | 006/120242 | 37 | 2.2 | 1126 | 25.1 | 31.4 | |
| 48 x 0.75 | 006/120244 | 48 | 2.2 | 972 | 25.7 | 32.2 | |
| 48 x 1.5 | 006/120245 | 48 | 2.4 | 1280 | 28.1 | 35.1 | |
| 48 x 2.5 | 006/120246 | 48 | 2.6 | 1960 | 31.2 | 39.0 | |

For price and delivery contact sales.

TEL:- (01782) 575316 FAX:- (01782) 834201 E-MAIL:-rseltd@btconnect.com

R.S.ELECTRICAL (RSE) LTD.

SPECIALIST SUPPLIERS TO THE RAIL INDUSTRY.

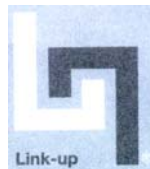

Type : E1 Tail Cables for use in cross track situations.
650/1100V, Flexible Conductor, EPR Compound
insulation. Heavy Duty PCP Sheath.
Railtrack specification RT/E/PS/00005

| No.Cores/ Size mm2 | Cat. No. | No. Of Cores | Radial Thickness mm sheath | Weight Kg/ Km | Cable OD Mm Min Max | | |
|-----------------------|------------|-----------------|-------------------------------|------------------|------------------------|------|--|
| 1 x 2.5 | 006/120172 | 1 | 3.8 | 174 | 11.2 | 14.0 | |

Type : E2 Tail Cables for use in cross track situations.
650/1100V, Flexible Conductor, EPR Compound insulation.
Heavy Duty PCP Sheath.
Railtrack specification RT/E/PS/00005

| No.Cores/ Size mm2 | Cat. No. | No. Of Cores | Radial Thickness mm sheath | Weight Kg/ Km | Cable OD Mm Min Max | | |
|-----------------------|------------|--------------|-------------------------------|------------------|------------------------|------|--|
| 2 x 2.5 | 006/120170 | 2 | 3.8 | 342 | 14.9 | 18.8 | |
| 4 x 2.5 | 006/120171 | 4 | 3.8 | 445 | 16.4 | 20.9 | |
| 7 x 2.5 | 006/120173 | 7 | 3.8 | 590 | 18.7 | 23.7 | |
| 10 x 2.5 | 006/120174 | 10 | 3.8 | 784 | 22.5 | 28.6 | |
| 12 x 2.5 | 006/120175 | 12 | 3.8 | 868 | 23.2 | 29.3 | |

Type : E3TPWS Tail Cables for use in cross track situations.
650/1100V, Flexible Conductor, EPR Compound insulation.
Heavy Duty PCP Sheath.
Railtrack specification RT/E/PS/00005

| No.Cores/ Size mm2 | Cat. No. | No. Of Cores | Radial Thickness mm sheath | Weight Kg/ Km | Cable OD Mm Min Max | | |
|-----------------------|------------|--------------|-------------------------------|------------------|------------------------|------|--|
| 1 x 2 x 2.5 | 006/160090 | 1 PAIR | 3.8 | 250 | 15 | 20.0 | |

For price and delivery contact sales.

TEL:- (01782) 575316 FAX:- (01782) 834201 E-MAIL:- rseltd@btconnect.com

R.S.ELECTRICAL (RSE) LTD.

SPECIALIST SUPPLIERS TO THE RAIL INDUSTRY.



Positive Track Feeder Cable 650/750VDC, uncompacted circular stranded Conductor, complying with BS6360.
Railtrack specification RT/E/S/21101

| No.Cores/ Size mm2 | Cat. No. | Conductor (mm ²) | Conductor Material | Min fixed Bend Radius | Cable Dia Mm | |
|-----------------------|------------|---------------------------------|-----------------------|--------------------------|--------------|------|
| | | | | | Core | O/D |
| 127x 3.20 | 006/116610 | 1000 | Aluminium | 530 | 41.6 | 53 |
| 127x 2.52 | 006/126612 | 630 | Copper | 354 | 44.2 | 354 |
| 61x 3.20 | 006/132840 | 500 | Aluminium | 387 | 28.8 | 42.2 |

Negative Track Feeder Cable 650/750VDC, uncompacted circular stranded Conductor, complying with BS6360.
Railtrack specification RT/E/S/21101

| No.Cores/ Size mm2 | Cat. No. | Conductor (mm ²) | Conductor Material | Min fixed Bend Radius | Cable Dia Mm | |
|-----------------------|------------|---------------------------------|-----------------------|--------------------------|--------------|------|
| | | | | | Core | O/D |
| 127x 2.85 | 006/132991 | 800 | Aluminium | 485 | 48.5 | 48.5 |
| 91x 2.65 | 006/132992 | 500 | Copper | 325 | 40.6 | 354 |
| 61x 2.25 | 006/132990 | 240 | Aluminium | 234 | 28.3 | 42.2 |
| 91x 1.53 | 006/132340 | 161 | Copper | 225 | 24.8 | 354 |
| 37x 2.25 | 006/116601 | 150 | Aluminium | 194 | 19.4 | 42.2 |

Aluminium Power Cables

| No.Cores/ Size mm2 | Cat. No. | Radial Thickness mm sheath | Weight Kg/Km | Cable OD mm |
|-----------------------|----------|-------------------------------|--------------|-------------|
| 2 x 16 | 6/142419 | 1.8 | 420 | 14.3 |
| 2 x 25 | 6/142519 | 1.8 | 455 | 16.6 |
| 2 x 35 | 6/142609 | 1.8 | 525 | 18.0 |
| 2 x 50 | 6/142629 | 1.8 | 620 | 20.4 |
| 2 x 70 | 6/142639 | 1.9 | 840 | 22.8 |
| 2 x 95 | 6/142644 | 2.0 | 1020 | 26.2 |
| 4 x 70 | 6/151469 | 2.0 | 1750 | 30.6 |

CABLE CLEANING

| BR.CAT.No | RSE.CAT.No. | DESCRIPTION |
|-----------|-------------|--|
| | 3M-WIPES | PRE-SOAKED SOLVENT WIPES FOR CLEANING AND DEGREASING 500 WIPES PER CONTAINER |

For price and delivery contact sales.

TEL:- (01782) 575316 FAX:- (01782) 834201 E-MAIL:- rseltd@btconnect.com

R.S.ELECTRICAL (RSE) LTD.

SPECIALIST SUPPLIERS TO THE RAIL INDUSTRY.



SECTION 7

SPECIALIST TRACKSIDE PRODUCTS.

THE PIRELLI FLEXO PORTFOLIO IS WIDE RANGING AND COMPREHENSIVE, OFFERING MANY CONNECTION APPLICATIONS THAT INCLUDE:-

- PRE-TERMINATED TRACK CONNECTION CABLES.
- TRACKSIDE CONNECTION BOXES.
- PRE-TERMINATED DETECTION CABLES.

AS WITH THE CABLE, WE ARE ABLE TO OFFER MANY OF THE TRACKSIDE PRODUCTS MANUFACTURED IN ZERO HALOGEN MATERIALS.

- PAGE 1-2. TRACKSIDE DISCONNECTION BOXES.
PAGE 3-4. PRE-TERMINATED TRACK CONNECTION CABLES.
PAGE 5. PRE-TERMINATED DETECTION SYSTEM CABLES.
PAGE 6-8. POINTS HEATING.
PAGE 9-10. DISCONNECTS FOR POINTS MACHINES.
PAGE 11. P CLIPS AND FASTENINGS.

For price and delivery contact sales.

TEL:- (01782) 575316 FAX:- (01782) 834201 E-MAIL:-rseltd@btconnect.com

[Return to top](#)

R.S.ELECTRICAL (RSE) LTD.

SPECIALIST SUPPLIERS TO THE RAIL INDUSTRY.

TRACKSIDE DISCONNECTION BOXES

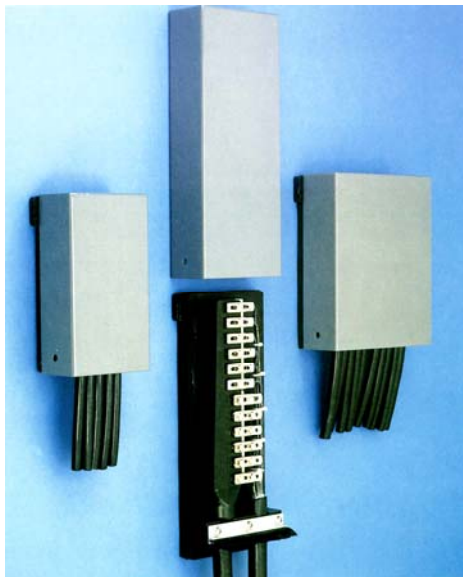
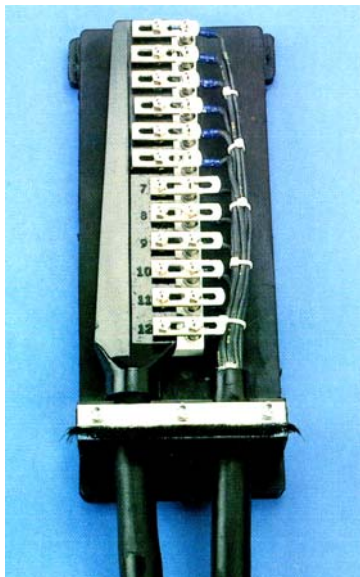

SMALL DISCONNECTION BOXES

| BR.CAT.No | RSE.CAT.No | DESCRIPTION | |
|-------------|------------|---------------------------------------|--|
| BR.86/43877 | W791730001 | TRACK CIRCUITS STYLE11211 | |
| BR.86/43879 | W791740001 | TCAID-D STYLE 11111 | |
| BR.86/43878 | W791750001 | TRACK CIRCUITS STYLE11112 | |
| BR.86/43880 | W791760001 | AWS STANDARD STYLE 20002 | |
| | W791790001 | AWS (CABLE ENTRY TYPE B2) STYLE 2002B | |
| BR.86/43881 | W791800001 | TCAID-N STYLE 30011 | |
| BR.86/43886 | W791810001 | 2 x 4 CORE STYLE 40004 | |
| BR.86/43887 | W791830001 | INDUCTOR AND SUPPRESSOR STYLE 2222 | |

LEVEL CROSSING TREADLE DISCONNECTION BOXES

| BR.CAT.No | RSE.CAT.No | DESCRIPTION | |
|-------------|------------|------------------------------------|--|
| BR.86/10756 | W791820001 | SINGLE | |
| BR.86/10757 | W791880001 | DOUBLE (1 x 12 CORE CABLE) STYLE A | |
| BR.86/10758 | W791870001 | DOUBLE (4 x 1 CORE CABLE) STYLE B | |
| BR.86/10759 | W791860001 | DOUBLE (2 x 4 CORE CABLE) STYLE C | |

For price and delivery contact sales.

TEL:- (01782) 575316 FAX:- (01782) 834201 E-MAIL:-rseltd@btconnect.com

R.S.ELECTRICAL (RSE) LTD.

SPECIALIST SUPPLIERS TO THE RAIL INDUSTRY.

TRACKSIDE DISCONNECTION BOXES



OTHER DISCONNECTION BOXES

| BR.CAT.No | RSE.CAT.No | DESCRIPTION | |
|-------------|------------|------------------------|--|
| BR.86/32121 | W791570001 | CLAMPLOCK | |
| | W791580001 | DIODE (LEVEL CROSSING) | |
| BR.86/10753 | W791890001 | 2 x 12 PIN | |

TPWS DISCONNECTION BOXES

| BR.CAT.No | RSE.CAT.No | DESCRIPTION | |
|-------------|------------|------------------------|--|
| BR.86/10761 | W791920001 | 3 WAY DISTRIBUTION BOX | |
| BR.86/10762 | W792190001 | 6 WAY DISTRIBUTION BOX | |

ANCILLIARY PRODUCTS FOR DISCONNECTION BOXES

| BR.CAT.No | RSE.CAT.No | DESCRIPTION | |
|-------------|------------|--|--|
| BR.86/10754 | W749980058 | POST MOUNTING KIT | |
| BR.86/10751 | W749980051 | STAKE (STANDARD,SHORT,NORMAL,GROUND) | |
| BR.86/88250 | W749980065 | STAKE (STANDARD,LONG, POOR,GROUND) | |
| BR.86/88260 | W749980072 | STAKE (STANDARD,EXTRA LONG, POOR ROUND) | |
| BR.86/88261 | W749980053 | STAKE (EXTRA LONG, TCAID APPLICATION TYPE) | |

For price and delivery contact sales.

TEL:- (01782) 575316 FAX:- (01782) 834201 E-MAIL:-rseltd@btconnect.com

R.S.ELECTRICAL (RSE) LTD.

SPECIALIST SUPPLIERS TO THE RAIL INDUSTRY.



PRE-TERMINATED TRACK CONNECTION CABLES



TRACK CIRCUIT LEAD WITH 2.5 (50/0.25) NEOPRENE CABLE

| BR.CAT.No | RSE.CAT.No | DESCRIPTION | |
|-------------|------------|--------------------|--|
| BR.86/44022 | W791600302 | 3M CABLE LENGTH | |
| BR.86/44023 | W791600506 | 4.5M CABLE LENGTH | |
| BR.86/44024 | W791600705 | 6.5M CABLE LENGTH | |
| BR.86/44025 | W791600807 | 8M CABLE LENGTH | |
| BR.86/44026 | W791603008 | 30M CABLE LENGTH | |
| BR.86/44029 | W791601820 | 17.5M CABLE LENGTH | |

TRACK CIRCUIT LEAD WITH 2.5 (50/0.25) LSF CABLE

| BR.CAT.No | RSE.CAT.No | DESCRIPTION | |
|-----------|------------|-------------------|--|
| | W791600311 | 3M CABLE LENGTH | |
| | W791600517 | 4.5M CABLE LENGTH | |
| | W791601018 | 9.5M CABLE LENGTH | |
| | W791600721 | 6.5M CABLE LENGTH | |
| | W791600822 | 8M CABLE LENGTH | |
| | W791603023 | 30M CABLE LENGTH | |

TRACK CIRCUIT LEAD WITH 35mm CABLE

| BR.CAT.No | RSE.CAT.No | DESCRIPTION | |
|-------------|------------|--------------------|--|
| BR.86/44103 | W791610101 | 1.2M CABLE LENGTH | |
| BR.86/44102 | W791610303 | 3M CABLE LENGTH | |
| | W791610304 | 3.5M CABLE LENGTH | |
| | W791610505 | 5M CABLE LENGTH | |
| BR.86/44040 | W791610207 | 1.65M CABLE LENGTH | |
| BR.86/44041 | W791610308 | 2.9M CABLE LENGTH | |

For price and delivery contact sales.

TEL:- (01782) 575316 FAX:- (01782) 834201 E-MAIL:- rseltd@btconnect.com

R.S.ELECTRICAL (RSE) LTD.

SPECIALIST SUPPLIERS TO THE RAIL INDUSTRY.



PRE-TERMINATED TRACK CONNECTION CABLES

TRACK CIRCUIT LEAD WITH 70mm CABLE

| BR.CAT.No | RSE.CAT.No | DESCRIPTION | |
|-------------|------------|-------------------|--|
| BR.86/44101 | W791610351 | 3M CABLE LENGTH | |
| BR.86/44100 | W791610552 | 4.8M CABLE LENGTH | |

MOULDED LEAD FOR YELLOW BONDING (35mm)

| BR.CAT.No | RSE.CAT.No | DESCRIPTION | |
|-------------|------------|-------------------|--|
| BR.86/44155 | W791620301 | 3M CABLE LENGTH | |
| BR.86/44154 | W791620402 | 4.5M CABLE LENGTH | |
| BR.86/44153 | W791620603 | 6.5M CABLE LENGTH | |
| BR.86/44152 | W791620804 | 8M CABLE LENGTH | |
| BR.86/44151 | W791623005 | 30M CABLE LENGTH | |

RAIL BONDING STUD CONNECTION LEADS, SINGLE ENDED

| BR.CAT.No | RSE.CAT.No | DESCRIPTION | |
|-------------|------------|-------------------|--|
| BR.86/44042 | W791710301 | 3M CABLE LENGTH | |
| BR.86/44043 | W791710402 | 4.5M CABLE LENGTH | |
| BR.86/44044 | W791710603 | 6.5M CABLE LENGTH | |
| BR.86/44045 | W791710804 | 8M CABLE LENGTH | |
| BR.86/44046 | W791713005 | 30M CABLE LENGTH | |

RAIL BONDING STUD CONNECTION LEADS, DOUBLE ENDED

| BR.CAT.No | RSE.CAT.No | DESCRIPTION | |
|-------------|------------|--------------------|--|
| BR.86/44048 | W791720101 | 0.85M CABLE LENGTH | |
| BR.86/44049 | W791720102 | 1.2M CABLE LENGTH | |
| BR.86/44047 | W791720203 | 1.6M CABLE LENGTH | |
| BR.86/44039 | W791720304 | 3M CABLE LENGTH | |

RAIL FASTENING KITS

| BR.CAT.No | RSE.CAT.No | DESCRIPTION | |
|-------------|------------|---------------------------------|--|
| BR.86/44017 | W749980043 | KIT TO SUIT 50/0.25 CABLE | |
| | W749980064 | KIT TO SUIT 35mm AND 70mm CABLE | |

All these Items can be made to order in any length of Cable.

For price and delivery contact sales.

TEL:- (01782) 575316 FAX:- (01782) 834201 E-MAIL:- rseltd@btconnect.com

R.S.ELECTRICAL (RSE) LTD.

SPECIALIST SUPPLIERS TO THE RAIL INDUSTRY.



PRE-TERMINATED DETECTION SYSTEM CABLES

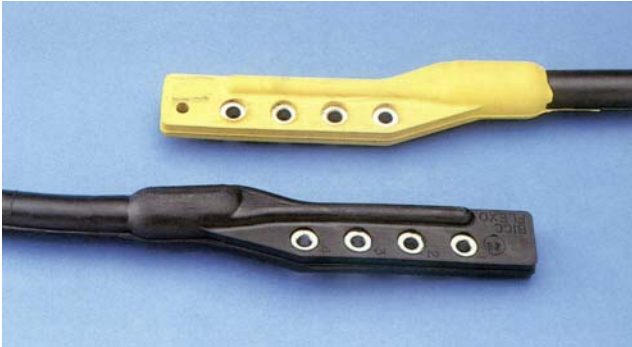

CLAMPLOCK DETECTOR LEADS DOUBLE ENDED

| BR.CAT.No | RSE.CAT.No | DESCRIPTION | |
|------------|------------|-------------------|--|
| BR.88/2444 | W722990301 | 2.3M CABLE LENGTH | |
| BR.88/2445 | W722990402 | 3.3M CABLE LENGTH | |
| BR.88/2446 | W722990403 | 4.2M CABLE LENGTH | |
| BR.88/2454 | W722990806 | 7.8M CABLE LENGTH | |
| | W722991007 | 10M CABLE LENGTH | |
| | W722991508 | 15M CABLE LENGTH | |

LEVEL CROSSING TREADLE LEADS WITH SILEC CONNECTOR

| BR.CAT.No | RSE.CAT.No | DESCRIPTION | |
|-------------|------------|-------------------|--|
| BR.86/44104 | W722980302 | 3M CABLE LENGTH | |
| BR.86/44105 | W722980503 | 4.5M CABLE LENGTH | |
| BR.86/44106 | W722980704 | 6.5M CABLE LENGTH | |
| BR.86/44107 | W722980805 | 8M CABLE LENGTH | |

LEVEL CROSSING TREADLE LEADS SINGLE ENDED

| BR.CAT.No | RSE.CAT.No | DESCRIPTION | |
|-------------|------------|-------------------|--|
| BR.86/44108 | W722970301 | 3M CABLE LENGTH | |
| BR.86/44109 | W722970502 | 4.5M CABLE LENGTH | |
| BR.86/44110 | W722970703 | 6.5M CABLE LENGTH | |
| BR.86/44111 | W722970804 | 8M CABLE LENGTH | |

12 CORE 50/0.25 SIGNALLING CABLES TERMINATED SINGLE ENDED

| BR.CAT.No | RSE.CAT.No | DESCRIPTION | |
|------------|------------|------------------|--|
| BR.88/2443 | W722950501 | 5M CABLE LENGTH | |
| BR.88/2442 | W722951002 | 10M CABLE LENGTH | |
| BR.88/2441 | W722951503 | 15M CABLE LENGTH | |
| BR.88/2440 | W722952004 | 20M CABLE LENGTH | |

For price and delivery contact sales.

TEL:- (01782) 575316 FAX:- (01782) 834201 E-MAIL:- rseltd@btconnect.com

R.S.ELECTRICAL (RSE) LTD.

SPECIALIST SUPPLIERS TO THE RAIL INDUSTRY.



POINTS HEATING (STRIP TYPE)

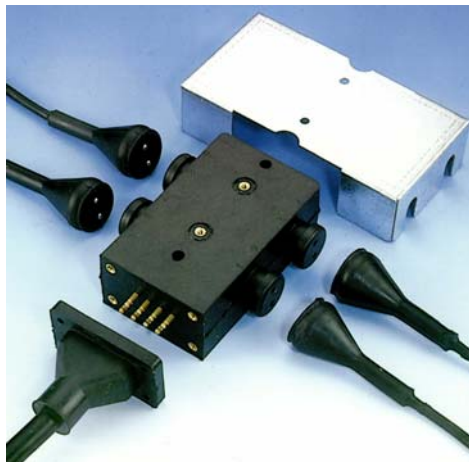

MOULDED PRODUCTS AND SPARES

| BR.CAT.No | RSE.CAT.No | DESCRIPTION | |
|-----------|------------|--|--|
| 54/88762 | W791530001 | 2 WAY SOCKET BLOCK TO SUIT 4 CORE 1.5mm CABLE | |
| 55/27679 | W791540001 | 4 WAY SOCKET BLOCK TO SUIT 8 CORE 1.5mm CABLE | |
| 55/27676 | W791540002 | 4 WAY SOCKET BLOCK TO SUIT 8 CORE 4.0mm CABLE | |
| 55/27677 | W791550002 | 8WAY SOCKET BLOCK TO SUIT 8 CORE 1.5mm CABLE | |
| 55/27678 | W791550001 | 8 WAY SOCKET BLOCK TO SUIT 8 CORE 4.0mm CABLE | |
| 55/51313 | W791440001 | REWIREABLE PLUG KIT FOR HEATER LEAD (4 PLUGS PER SET) | |
| 55/27591 | W740200101 | EXTENSION LEAD FOR HEATER CABLE | |
| 55/39619 | W749990022 | SPARE Z BRACKET TO SUIT 4 WAY BLOCK | |
| 55/39618 | W749990032 | SPARE Z BRACKET TO SUIT 8 WAY BLOCK | |

POINTS HEATING (STRIP TYPE)

MOULDED PRODUCTS AND SPARES

| BR.CAT.No | RSE.CAT.No | DESCRIPTION | |
|-----------|------------|---|--|
| 6/147001 | F105813220 | 2 CORE 1.0mm CABLE, EPR/CPC | |
| 6/150002 | F105819520 | 4 CORE 1.5mm CABLE, EPR/CPC | |
| 6/153102 | F105819530 | 8 CORE 1.5mm CABLE, EPR/CPC | |
| 6/153103 | F105819540 | 8 CORE 4.0mm CABLE, EPR/CPC | |
| | 409AA56 | GLAND TO SUIT 8 CORE 4mm CABLE | |
| | 409AA55 | GLAND TO SUIT 8 CORE 1.5mm CABLE AND 4 CORE 1.5mm | |

For price and delivery contact sales.

TEL:- (01782) 575316 FAX:- (01782) 834201 E-MAIL:- rseltd@btconnect.com

R.S.ELECTRICAL (RSE) LTD.

SPECIALIST SUPPLIERS TO THE RAIL INDUSTRY.

POINTS HEATING (HARNESS TYPE)



8 CORE HARNESSES WITH PLUG AND REWIREABLE SOCKET

| BR.CAT.No | RSE.CAT.No | DESCRIPTION | |
|-----------|------------|-------------|--|
| 55/26969 | W790920404 | 4 OUTLETS | |
| 55/26968 | W790920405 | 5 OUTLETS | |
| 55/26967 | W790920406 | 6 OUTLETS | |
| 55/26966 | W790920407 | 7 OUTLETS | |
| 55/26965 | W790920408 | 8 OUTLETS | |
| 55/26964 | W790920409 | 9 OUTLETS | |
| 55/26963 | W790920410 | 10 OUTLETS | |
| 55/26971 | W790920411 | 11 OUTLETS | |
| 55/26972 | W790920412 | 12 OUTLETS | |

8 CORE HARNESSES WITH PLUG AND REWIREABLE SOCKET

| BR.CAT.No | RSE.CAT.No | DESCRIPTION | |
|-----------|------------|-------------|--|
| 55/27036 | W791470404 | 4 OUTLETS | |
| 55/27037 | W791470405 | 5 OUTLETS | |
| 55/27038 | W791470506 | 6 OUTLETS | |
| 55/27039 | W791470607 | 7 OUTLETS | |
| 55/27040 | W791470708 | 8 OUTLETS | |
| 55/27041 | W791470809 | 9 OUTLETS | |
| 55/27042 | W791470810 | 10 OUTLETS | |
| 55/27043 | W791470911 | 11 OUTLETS | |
| 55/27044 | W791471012 | 12 OUTLETS | |
| 55/27044 | W791471113 | 13 OUTLETS | |
| 55/27044 | W791471114 | 14 OUTLETS | |
| 55/27044 | W791471215 | 15 OUTLETS | |

For price and delivery contact sales.

TEL:- (01782) 575316 FAX:- (01782) 834201 E-MAIL:- rseltd@btconnect.com

R.S.ELECTRICAL (RSE) LTD.

SPECIALIST SUPPLIERS TO THE RAIL INDUSTRY.



POINTS HEATING (HARNESS TYPE)

2 CORE BACK TO BACK HARNESSES WITH PLUG AND REWIREABLE SOCKET

| <u>BR.CAT.No</u> | <u>RSE.CAT.No</u> | <u>DESCRIPTION</u> | |
|------------------|-------------------|--------------------|--|
| 55/27068 | W791500506 | 12 OUTLETS | |
| 55/27063 | W791500607 | 14 OUTLETS | |
| 55/27064 | W791500708 | 16 OUTLETS | |
| 55/27066 | W791500809 | 18 OUTLETS | |
| 55/27067 | W791500810 | 20 OUTLETS | |
| 55/27070 | W791501012 | 24 OUTLETS | |

8 CORE HARNESSES WITH FREE END (NON PREFERRED)

| <u>BR.CAT.No</u> | <u>RSE.CAT.No</u> | <u>DESCRIPTION</u> | |
|------------------|-------------------|--------------------|--|
| 55/26976 | W791250404 | 4 OUTLETS | |
| 55/26977 | W791250405 | 5 OUTLETS | |
| 55/26978 | W791250506 | 6 OUTLETS | |
| 55/26974 | W791250607 | 7 OUTLETS | |
| 55/26979 | W791250708 | 8 OUTLETS | |
| 55/26975 | W791250709 | 9 OUTLETS | |
| 55/26980 | W791250810 | 10 OUTLETS | |
| 55/27034 | W791250911 | 11 OUTLETS | |
| 55/26998 | W791251012 | 12 OUTLETS | |

For price and delivery contact sales.

TEL:- (01782) 575316 FAX:- (01782) 834201 E-MAIL:- rseltd@btconnect.com

R.S.ELECTRICAL (RSE) LTD.

SPECIALIST SUPPLIERS TO THE RAIL INDUSTRY.

DISCONNECTS FOR POINTS MACHINES

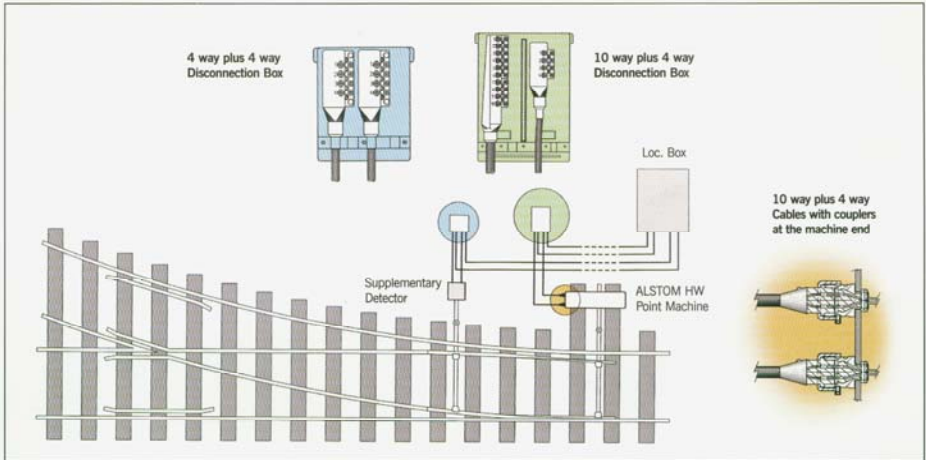

| BR.CAT.No | RSE.CAT.No | DESCRIPTION | |
|--------------|------------|-------------------------------------|--|
| BR.88/000500 | W722800101 | 4 WAY PLUG COUPLER WITH 1 MTR TAILS | |
| BR.88/000501 | W722790101 | 4 WAY PLUG COUPLER WITH 1 MTR TAILS | |
| | | | |
| BR.88/000502 | W792120001 | 4 WAY + 4 WAY DISTRIBUTION BOX | |
| BR.88/000503 | W792130001 | 10 WAY + 4 WAY DISTRIBUTION BOX | |
| | | | |
| | | 4 WAY SOCKET COUPLER WITH FREE END | |
| BR.88/000504 | W722700501 | 5 MTR. CABLE LENGTH | |
| BR.88/000505 | W722701002 | 10 MTR. CABLE LENGTH | |
| BR.88/000506 | W722701503 | 15 MTR. CABLE LENGTH | |
| BR.88/000507 | W722702004 | 20 MTR. CABLE LENGTH | |
| | | | |
| | | 10 WAY SOCKET COUPLER WITH FREE END | |
| BR.88/000508 | W722690501 | 5 MTR. CABLE LENGTH | |
| BR.88/000509 | W722691002 | 10 MTR. CABLE LENGTH | |
| BR.88/000510 | W722691503 | 15 MTR. CABLE LENGTH | |
| BR.88/000511 | W722692004 | 20 MTR. CABLE LENGTH | |
| | | | |
| | 4 WAY | MOULDED TERMINATION WITH FREE END | |
| BR.88/000512 | W722890501 | 5 MTR. CABLE LENGTH | |
| BR.88/000513 | W722891002 | 10 MTR. CABLE LENGTH | |
| BR.88/000514 | W722891503 | 15 MTR. CABLE LENGTH | |
| BR.88/000515 | W722892004 | 20 MTR. CABLE LENGTH | |

For price and delivery contact sales.

TEL:- (01782) 575316 FAX:- (01782) 834201 E-MAIL:- rseltd@btconnect.com

R.S.ELECTRICAL (RSE) LTD.

SPECIALIST SUPPLIERS TO THE RAIL INDUSTRY.

DISCONNECTS FOR POINTS MACHINES



| BR.CAT.No | RSE.CAT.No | DESCRIPTION | |
|------------------|-------------------|--|--|
| | | 10 WAY MOULDED TERMINATION WITH FREE END | |
| BR.88/000516 | W722900501 | 5 MTR. CABLE LENGTH | |
| BR.88/000517 | W722901002 | 10 MTR. CABLE LENGTH | |
| BR.88/000518 | W722901503 | 15 MTR. CABLE LENGTH | |
| BR.88/000519 | W722902004 | 20 MTR. CABLE LENGTH | |
| | | | |
| | | 4 WAY SOCKET COUPLER WITH 4 WAY MOULDED TER- MINATION | |
| BR.88/000520 | W722870501 | 5 MTR. CABLE LENGTH | |
| BR.88/000521 | W722871002 | 10 MTR. CABLE LENGTH | |
| BR.88/000522 | W722871503 | 15 MTR. CABLE LENGTH | |
| BR.88/000523 | W722872004 | 20 MTR. CABLE LENGTH | |
| | | | |
| | | 10 WAY SOCKET COUPLER WITH 10 WAY MOULDED TERMINATION | |
| BR.88/000524 | W722860501 | 5 MTR. CABLE LENGTH | |
| BR.88/000525 | W722861002 | 10 MTR. CABLE LENGTH | |
| BR.88/000526 | W722861503 | 15 MTR. CABLE LENGTH | |
| BR.88/000527 | W722862004 | 20 MTR. CABLE LENGTH | |

Other Cable Lengths can be Manufactured to Order

For price and delivery contact sales.

TEL:- (01782) 575316 FAX:- (01782) 834201 E-MAIL:-rseltd@btconnect.com

R.S.ELECTRICAL (RSE) LTD.

SPECIALIST SUPPLIERS TO THE RAIL INDUSTRY.



SIGNALS SUNDRY ITEMS



| BR.CAT.No | RSE.CAT.No | DESCRIPTION |
|-----------|------------|---------------------------|
| | BR.RSE-11 | TUFNOL WASHER FOR SIGNALS |

P-CLIPS AND FASTENINGS

| BR.CAT.No | RSE.CAT.No. | DESCRIPTION |
|---------------|--------------------|--|
| | PMASGB09/PCLIP12 | 12mm DIAMETER P-CLIP |
| | PMASGB11/PCLIP16 | 16mm DIAMETER P-CLIP |
| | PMASGB16/PCLIP20 | 20mm DIAMETER P-CLIP |
| | PMASGB21/PCLIP25 | 25mm DIAMETER P-CLIP |
| | PMASGB29/PCLIP32 | 32mm DIAMETER P-CLIP |
| BR.088/002545 | 246787 | FB13 CLIP FOR 13mm CABLE |
| BR.088/002546 | 053082 | FB20 CLIP FOR 20mm CABLE |
| BR.054/010336 | 054283 | SF12GA CLIP FOR 12mm CABLE |
| BR.054/010337 | 054285 | SF16GA CLIP FOR 16mm CABLE |
| BR.054/010338 | 054287 | SF20GA CLIP FOR 20mm CABLE |
| BR.054/011647 | 054289 | SF25GA CLIP FOR 25mm CABLE |
| BR.054/010339 | 053848 | SF32GA CLIP FOR 32mm CABLE |
| BR.39/001029 | 205304 | SDS 6mm CARBIDE TIPPED DRILL BIT |
| | BR.00219038/SMD25Z | FIXINGS FOR STEEL SLEEPERS (Self Drill and Tap) |
| | BR.TEKSA8B | 8mm HEXAGONAL SOCKET (Driving Bit For SD25Z Fixings) |
| | BR.00230517 | HAMMER FIXINGS FOR CONCRETE SLEEPERS |
| | BR.WZ11 | SLEEPER FIXING CRADLE |
| | BR.SSEC15 | EARTH STRAP |

For price and delivery contact sales.

TEL:- (01782) 575316 FAX:- (01782) 834201 E-MAIL:- rseltd@btconnect.com

R.S.ELECTRICAL (RSE) LTD.

SPECIALIST SUPPLIERS TO THE RAIL INDUSTRY.



SECTION 8

CRIMPS, CLAMPS AND CRIMPING TOOLS.

THIS SECTION CONTAINS ALL THE ACCESSORIES REQUIRED FROM PIDG CRIMPS TO CLAMPS AND CRIMPING TOOLS. WE CARRY LARGE STOCKS AND CAN OFFER SAME DAY DESPATCH ON MANY OF THESE PRODUCTS.

- PAGE 1. AMP PIDG CRIMP TERMINALS.
- PAGE 2. CRIMPING TOOLS, STORAGE BOXES.
- PAGE 3. NYLON CRIMPS.
- PAGE 4. UN-INSULATED CRIMP LUGS.
- PAGE 5. CRIMPING TOOLS AND DIE SETS.
- PAGE 6. POWER CABLE CRIMPS.
- PAGE 7. CABLE LINKS (THROUGH CONNECTORS)

For price and delivery contact sales.

TEL:- (01782) 575316 FAX:- (01782) 834201 E-MAIL:- rseltd@btconnect.com

[Return to top](#)

R.S.ELECTRICAL (RSE) LTD.

SPECIALIST SUPPLIERS TO THE RAIL INDUSTRY.



AMP PIDG CRIMP TERMINALS



| BR.CAT.No | RSE.CAT.No. | DESCRIPTION | |
|-----------|-------------|---|--|
| | AMP31650 | Red Ring Crimp M3.5 Hole Size | |
| | AMP32836 | Red Ring Crimp M5/2BA Hole Size (AMEY RAIL) | |
| 54/119387 | AMP130008 | Red Ring Crimp M5/2BA Hole Size | |
| 54/119391 | AMP320571 | Red Ring Crimp M6/0BA Hole Size | |
| 54/119364 | AMP130663 | Blue Ring Crimp M5/2BA Hole Size | |
| 54/119366 | AMP320563 | Blue Ring Crimp M6/0BA Hole Size | |
| 54/120028 | AMP130167 | Yellow Ring Crimp M5/2BA Hole Size | |
| 54/120029 | AMP320569 | Yellow Ring Crimp M6/0BA Hole Size | |
| | AMP320576 | Yellow Ring Crimp M8 Hole Size | |
| 54/119567 | AMP342062 | Black Ring Crimp M5/2BA Hole Size | |
| 54/119568 | AMP342063 | Black Ring Crimp M6/0BA Hole Size | |
| 54/119501 | AMP150730 | Red Blade | |
| 54/119502 | AMP790347 | Blue Blade | |
| | AMP154708 | Red Hooked Blade | |
| 54/119588 | AMP154724 | Blue Hooked Blade | |
| 54/119342 | AMP165142 | Red Pin 12mm Long | |
| 54/119344 | AMP165046 | Blue Pin 12mm Long | |
| | AMP165049 | Yellow Pin Crimp | |
| 54/119352 | AMP320559 | Red Butt / Splice | |
| 54/119478 | AMP320562 | Blue Butt / Splice | |
| 54/119005 | AMP36964 | Purple Bomb Tail | |
| 54/119003 | AMP34308 | Yellow Bomb Tail | |
| | AMP150822 | Black Insulated Snap | |
| | AMP34080 | Red Forked Crimp | |
| | AMP320568 | Yellow Ring Crimp M4 Hole Size | |
| | AMP130207 | Yellow Ring Crimp M10 Hole Size | |
| | AMP326859 | Yellow Fork Crimp | |
| | AMP327583 | Blue Splice Crimp | |
| | AMP320570 | Yellow Splice Crimp | |

For price and delivery contact sales.

TEL:- (01782) 575316 FAX:- (01782) 834201 E-MAIL:- rseltd@btconnect.com

R.S.ELECTRICAL (RSE) LTD.

SPECIALIST SUPPLIERS TO THE RAIL INDUSTRY.

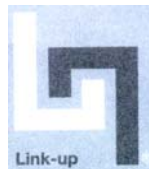

AMP. Crimping Tools.

| BR.CAT.No | RSE.CAT.No. | DESCRIPTION | |
|-----------|----------------|--|--|
| 39/008126 | 47386/525690 | Red Crimping Tool | |
| 39/008123 | 47387/525691 | Blue Crimping Tool | |
| 39/008127 | 525692/59239-4 | Yellow Crimping Tool | |
| 39/49584 | AMPRTB-S10-BRK | CTT Crimping Toolkit with 4 Interchangeable Locator fitted Dies and Carrying Case. | |
| | AMPCT/70R | Crimping Tool | |



Crimp Storage Box

| BR.CAT.No | RSE.CAT.No. | DESCRIPTION | |
|-----------|-------------|-------------------|--|
| | BR.RSE-10 | CRIMP STORAGE BOX | |

For price and delivery contact sales.

TEL:- (01782) 575316 FAX:- (01782) 834201 E-MAIL:- rseltd@btconnect.com

R.S.ELECTRICAL (RSE) LTD.

SPECIALIST SUPPLIERS TO THE RAIL INDUSTRY.



NYLON INSULATED RING CRIMPS

| BR.CAT.No | RSE.CAT.No. | DESCRIPTION | |
|------------------|--------------------|--------------------|--|
| | CEMANE2-M5 | 10mm M5/2BA Crimp | |
| | CEMANE3-M5 | 16mm M5/2BA Crimp | |
| | CEMANE5-M5 | 25mm M5/2BA Crimp | |
| | CEMANE9-M5 | 35mm M5/2BA Crimp | |
| | CEMANE2-M6 | 10mm M6/0BA Crimp | |
| | CEMANE3-M6 | 16mm M6/0BA Crimp | |
| | CEMANE5-M6 | 25mm M6/0BA Crimp | |
| | CEMANE9-M6 | 35mm M6/0BA Crimp | |

NYLON INSULATED PIN CRIMPS

| BR.CAT.No | RSE.CAT.No. | DESCRIPTION | |
|------------------|--------------------|--------------------|--|
| | CEMANE2-P12 | 10mm Pin Crimp | |
| | CEMANE3-P14 | 16mm Pin Crimp | |
| | CEMANE5-P16 | 25mm Pin Crimp | |
| | CEMANE7-P20 | 35mm Pin Crimp | |

For price and delivery contact sales.

TEL:- (01782) 575316 FAX:- (01782) 834201 E-MAIL:-rseltd@btconnect.com

R.S.ELECTRICAL (RSE) LTD.

SPECIALIST SUPPLIERS TO THE RAIL INDUSTRY.



UN-INSULATED CRIMP LUGS

| BR.CAT.No. | RSE.CAT.No. | DESCRIPTION | |
|------------|-------------|---------------|--|
| | CEMS6-M16 | 6mm x M16 | |
| | CEMA2-M5 | 10mm x M5/2BA | |
| | CEMA2-M6 | 10mm x M6/0BA | |
| | CEMA2-M8 | 10mm x M8 | |
| | CEMA2-M10 | 10mm x M10 | |
| | CEMA2-M16 | 10mm x M16 | |
| | CEMA3-M5 | 16mm x M5/2BA | |
| | CEMA3-M6 | 16mm x M6/0BA | |
| | CEMA3-M8 | 16mm x M8 | |
| | CEMA3-M10 | 16mm X M10 | |
| | CEMA3-M12 | 16mm x M12 | |
| | CEMA5-M5 | 25mm X M5/2BA | |
| | CEMA5-M6 | 25mm X M6/0BA | |
| | CEMA5-M8 | 25mm X M8 | |
| | CEMA5-M10 | 25mm x M10 | |
| | CEMA5-M12 | 25mm x M12 | |
| | CEMA5-M16 | 25mm x M16 | |
| | CEMA7-M5 | 35mm x M5/2BA | |
| | CEMA7-M6 | 25mm x M6/0BA | |
| | CEMA7-M8 | 35mm x M8 | |
| | CEMA7-M10 | 35mm x M10 | |
| | CEMA7-M16 | 35mm x M16 | |

For price and delivery contact sales.

TEL:- (01782) 575316 FAX:- (01782) 834201 E-MAIL:-rseltd@btconnect.com

R.S.ELECTRICAL (RSE) LTD.

SPECIALIST SUPPLIERS TO THE RAIL INDUSTRY.



CRIMPING TOOLS

Suitable for Insulated & Un-Insulated

| BR.CAT.No | RSE.CAT.No. | DESCRIPTION | |
|-----------|-------------|----------------------------|--|
| | CEMHT51 | LIGHTWEIGHT HYDRAULIC TOOL | |

Die Sets

| BR.CAT.No | RSE.CAT.No. | SIZE | |
|-----------|-------------|---------|--|
| | CEMME1-50 | 4 — 6mm | |
| | CEMME2-50 | 10mm | |
| | CEMME3-50 | 16mm | |
| | CEMME5-50 | 25mm | |
| | CEMME7-50 | 35mm | |

Un-Insulated Die Sets

| BR.CAT.No | RSE.CAT.No. | SIZE | |
|-----------|-------------|------|--|
| | CEMMN2-RF50 | 10mm | |
| | CEMMN3-RF50 | 16mm | |
| | CEMMN5-RF50 | 25mm | |
| | CEMMN7-RF50 | 35mm | |

SSI Crimping Tools

| BR.CAT.No | RSE.CAT.No. | DESCRIPTION | |
|-----------|-------------|---------------|--|
| | CEMAF8-DAN | CRIMPING TOOL | |

Die Sets

| BR.CAT.No | RSE.CAT.No. | DESCRIPTION | |
|-----------|----------------|------------------|--|
| | CEMTH499 | DIE SETS TO SUIT | |
| | CEM192922-1450 | EXTRACTOR TOOLS | |

For price and delivery contact sales.

TEL:- (01782) 575316 FAX:- (01782) 834201 E-MAIL:- rseltd@btconnect.com

R.S.ELECTRICAL (RSE) LTD.

SPECIALIST SUPPLIERS TO THE RAIL INDUSTRY.



POWER CABLE CRIMPS

2 - CORE

| BR.CAT.No | RSE.CAT.No. | DESCRIPTION | |
|--------------|-------------|-------------------------|--|
| | BA16A2-6 | 16mm CABLE 0BA/6mm HOLE | |
| | BA16A2-8 | 16mm CABLE 8mm HOLE | |
| | BA16A2-10 | 16mm CABLE 10mm HOLE | |
| | | | |
| | BA25A2- 6 | 25mm CABLE 0BA/6mm HOLE | |
| | BA25A2- 8 | 25mm CABLE 8mm HOLE | |
| BR.54/103716 | BA25A2- 10 | 25mm CABLE 10mm HOLE | |
| | | | |
| | BA35A2- 6 | 35mm CABLE 0BA/6mm HOLE | |
| | BA35A2- 8 | 35mm CABLE 8mm HOLE | |
| BR.54/103717 | BA35A2- 10 | 35mm CABLE 10mm HOLE | |
| | | | |
| | BA50A2- 8 | 50mm CABLE 8mm HOLE | |
| BR.54/103718 | BA50A2- 10 | 50mm CABLE 10mm HOLE | |
| | | | |
| | BA70A2- 8 | 70mm CABLE 8mm HOLE | |
| | BA70A2- 10 | 70mm CABLE 10mm HOLE | |
| BR.54/103719 | BA70A2- 12 | 70mm CABLE 12mm HOLE | |
| | | | |
| BR.54/103720 | BA95A2- 10 | 95mm CABLE 10mm HOLE | |

4 - CORE

| BR.CAT.No | RSE.CAT.No. | DESCRIPTION | |
|--------------|-------------|----------------------|--|
| BR.54/103730 | BA70A4- 10 | 70mm CABLE 10mm HOLE | |
| | BA70A4- 12 | 70mm CABLE 12mm HOLE | |
| | BA70A4- 16 | 70mm CABLE 16mm HOLE | |

For price and delivery contact sales.

TEL:- (01782) 575316 FAX:- (01782) 834201 E-MAIL:-rseltd@btconnect.com

R.S.ELECTRICAL (RSE) LTD.

SPECIALIST SUPPLIERS TO THE RAIL INDUSTRY.

CABLE LINKS (Through Connectors)



| BR.CAT.No | RSE.CAT.No. | DESCRIPTION | |
|------------------|--------------------|-------------------------------|--|
| | BA16A2S | 16mm 2 - CORE CABLE LINK | |
| BR.54/114102 | BA25A2S | 25mm 2 - CORE CABLE LINK | |
| BR.54/114103 | BA35A2S | 35mm 2 - CORE CABLE LINK | |
| BR.54/114104 | BA50A2S | 50mm 2 - CORE CABLE LINK | |
| BR.54/114105 | BA75A2S | 75mm 2 - CORE CABLE LINK | |
| BR.54/114108 | BA95A2S | 95mm 2 - CORE CABLE LINK | |
| | | | |
| BR.54/114122 | BA70A4S | 70mm 4 - CORE CABLE LINK | |
| | | | |
| | BM95M | 16 - 95mm SHEAROFF CABLE LINK | |

CRIMPING TOOLS

PIRELLI ALUMINIUM POWER CABLE

| BR.CAT.No | RSE.CAT.No. | DESCRIPTION | |
|------------------|--------------------|---------------------------|--|
| | BR.G10TS | 10 - 120mm HYDRAULIC TOOL | |
| | BR.BX25 / 70CHEX | 25/70mm Die Set | |
| | BR.BX35 / 50CHEX | 35/50mm Die Set | |
| | BR.BX95CHEX | 95mm Die Set | |

* Please Note the above Dies will also fit through connectors

For price and delivery contact sales.

TEL:- (01782) 575316 FAX:- (01782) 834201 E-MAIL:- rseltd@btconnect.com



SECTION 9

CABLE MANAGEMENT

BETADUCT AND ACCESSORIES

LPA TRAY

EGA DUCT

MITA RAIL PRODUCTS (TRAY AND TROUGHING)

MARSHALL TUFFLEX TRAY (PREVIOUSLY HAGER)

PMA CONDUITS

FLEXICON CONDUITS

THIS SECTION SHOWS ALL CABLE MANAGEMENT SYSTEMS AVAILABLE IN GRP PLASTIC, NORYL NYLON, ZERO HALOGEN AND GALVANISED STEEL. MANY OF THESE PRODUCTS ARE AVAILABLE EX-STOCK. FOR MITA AND MARSHALL TUFFLEX, DETAILS ARE AVAILABLE ON REQUEST, ALSO IF YOU REQUIRE ANY CATALOGUES ON THESE PRODUCTS, PLEASE CONTACT US.

- PAGE 1. CLOSED SLOT BETADUCT (GREY).
- PAGE 2. CLOSED SLOT BETADUCT (BLACK).
- PAGE 3. PLAIN BETADUCT.
- PAGE 4. NORYL BETADUCT.
- PAGE 5. BETADUCT DIVIDERS AND END PLATES.
- PAGE 6. GROMMET STRIP AND SPIROBAND.
- PAGE 7. EGA HEAVY DUTY PLAIN CABLE DUCTING.
- PAGE 8. LPA TRAY.
- PAGE 9. MITA HEAVY DUTY PVC CABLE TRAY AND ACCESSORIES
- PAGE 10. MITA GRP ELEVATED CABLE TROUGHING.
- PAGE 11-12. STEEL CABLE TRAY AND ACCESSORIES.
- PAGE 13. PMA CONDUIT AND FITTINGS.
- PAGE 14. PMA ZERO HALOGEN CONDUIT AND FITTINGS.

For price and delivery contact sales.

TEL:- (01782) 575316 FAX:- (01782) 834201 E-MAIL:- rseltd@btconnect.com

R.S.ELECTRICAL (RSE) LTD.

SPECIALIST SUPPLIERS TO THE RAIL INDUSTRY.



CLOSED SLOT BETADUCT (GREY)

| BR.CAT.No. | RSE.CAT.No. | DESCRIPTION | |
|-------------------|--------------------|-------------------------------|--|
| 54/160007 | RAVE10460022 | 25mm WIDE x 37.5mm HIGH x 24M | |
| 54/073289 | RAVE10460023 | 25mm WIDE x 50mm HIGH x 24M | |
| 54/073295 | RAVE10460024 | 25mm WIDE x 75mm HIGH x 16M | |
| 54/073296 | RAVE10460053 | 50mm WIDE x 50mm HIGH x 16M | |
| 54/073297 | RAVE10460054 | 50mm WIDE x 75mm HIGH x 16M | |
| 54/073298 | RAVE10460074 | 75mm WIDE x 75mm HIGH x 16M | |
| | RAVE10460051 | 50mm WIDE x 25mm HIGH x 24M | |
| | RAVE10460073 | 75mm WIDE x 50mm HIGH x 16M | |
| | RAVE10460103 | 100mm WIDE x 50mm HIGH x 8M | |
| | RAVE10460104 | 100mm WIDE x 75mm HIGH x 8M | |
| | RAVE10460106 | 100mm WIDE x 125mm HIGH x 8M | |
| | RAVE10460124 | 125mm WIDE x 75mm HIGH x 8M | |
| | NENHE329GR | GREY ANGLE STRIP | |
| | NENHE327BL | BLACK ANGLE STRIP | |
| | RAVE1050 | BETADUCT RIVETS | |

For price and delivery contact sales.

TEL:- (01782) 575316 FAX:- (01782) 834201 E-MAIL:- rseltd@btconnect.com

R.S.ELECTRICAL (RSE) LTD.

SPECIALIST SUPPLIERS TO THE RAIL INDUSTRY.



CLOSED SLOT BETADUCT (BLACK)

| BR.CAT.No | RSE.CAT.No. | CABLE SIZE | |
|-----------|-------------|-------------------------------|--|
| 54/160048 | RAVE0900 | 15mm wide x 15mm high x 48M | |
| 54/160008 | RAVE0951 | 25mm wide x 37.5mm high x 24M | |
| 54/160019 | RAVE0903 | 25mm wide x 50mm high x 24M | |
| 54/073059 | RAVE0904 | 25mm wide x 75mm high x 16M | |
| 54/160026 | RAVE0906 | 50mm wide x 50mm high x 16M | |
| 54/160035 | RAVE0907 | 50mm wide x 75mm high x 16M | |
| 54/160033 | RAVE0909 | 75mm wide x 75mm high x 16M | |
| | RAVE0938 | 50mm wide x 25mm high x 24M | |
| | RAVE0964 | 75mm wide x 50mm high x 16M | |
| | RAVE0968 | 100mm wide x 50mm high x 8M | |
| | RAVE0969 | 100mm wide x 75mm high x 8M | |
| | RAVE0971 | 100mm wide x 125mm high x 8M | |
| | RAVE0940 | 125mm wide x 75mm high x 8M | |

For price and delivery contact sales.

TEL:- (01782) 575316 FAX:- (01782) 834201 E-MAIL:-rseltd@btconnect.com

R.S.ELECTRICAL (RSE) LTD.

SPECIALIST SUPPLIERS TO THE RAIL INDUSTRY.



PLAIN BETADUCT (GREY)

| BR.CAT.No | RSE.CAT.No. | CABLE SIZE | |
|-----------|--------------|-------------------------------|--|
| 54/073281 | RAVE10480011 | 15mm wide x 15mm high x 48M | |
| 54/020253 | RAVE10480022 | 25mm wide x 37.5mm high x 24M | |
| 54/073274 | RAVE10480023 | 25mm wide x 50mm high x 24M | |
| 54/073299 | RAVE10480024 | 25mm wide x 75mm high x 16M | |
| 54/073301 | RAVE10480053 | 50mm wide x 50mm high x 16M | |
| 54/073302 | RAVE10480054 | 50mm wide x 75mm high x 16M | |
| 54/073303 | RAVE10480074 | 75mm wide x 75mm high x 16M | |
| | RAVE10480073 | 75mm wide x 50mm high x 16M | |
| | RAVE10480103 | 100mm wide x 50mm high x 8M | |
| | RAVE10480104 | 100mm wide x 75mm high x 8M | |
| | RAVE10480105 | 100mm wide x 100mm high x 8M | |
| | RAVE10480106 | 100mm wide x 125mm high x 8M | |
| | RAVE10480124 | 125mm wide x 75mm high x 8M | |



PLAIN BETADUCT (BLACK)

| BR.CAT.No | RSE.CAT.No. | CABLE SIZE | |
|-----------|-------------|-------------------------------|--|
| 54/160049 | RAVE0920 | 15mm wide x 15mm high x 48M | |
| 54/160012 | RAVE1011 | 25mm wide x 37.5mm high x 24M | |
| 54/160016 | RAVE0923 | 25mm wide x 50mm high x 24M | |
| 54/160027 | RAVE0926 | 50mm wide x 50mm high x 16M | |
| 54/160036 | RAVE0927 | 50mm wide x 75mm high x 16M | |
| 54/160039 | RAVE0929 | 75mm wide x 75mm high x 16M | |

For price and delivery contact sales.

TEL:- (01782) 575316 FAX:- (01782) 834201 E-MAIL:-rseltd@btconnect.com

R.S.ELECTRICAL (RSE) LTD.

SPECIALIST SUPPLIERS TO THE RAIL INDUSTRY.



NORYL BETADUCT CLOSED SLOT

| BR.CAT.No | RSE.CAT.No. | CABLE SIZE | |
|-----------|--------------|---------------------------|--|
| | RAVE23452000 | 25 x 50 BLACK CLOSED SLOT | |
| | RAVE23453000 | 25 x 75 BLACK CLOSED SLOT | |
| | RAVE23454000 | 50 x 50 BLACK CLOSED SLOT | |
| | RAVE23455000 | 50 x 75 BLACK CLOSED SLOT | |
| | RAVE23456000 | 75 x 75 BLACK CLOSED SLOT | |



NORYL BETADUCT PLAIN

| BR.CAT.No | RSE.CAT.No. | CABLE SIZE | |
|-----------|--------------|---------------------|--|
| | RAVE23472000 | 25 x 50 BLACK PLAIN | |
| | RAVE23473000 | 25 x 75 BLACK PLAIN | |
| | RAVE23474000 | 50 x 50 BLACK PLAIN | |
| | RAVE23475000 | 50 x 75 BLACK PLAIN | |
| | RAVE23476000 | 75 x 75 BLACK PLAIN | |

For price and delivery contact sales.

TEL:- (01782) 575316 FAX:- (01782) 834201 E-MAIL:-rseltd@btconnect.com

R.S.ELECTRICAL (RSE) LTD.

SPECIALIST SUPPLIERS TO THE RAIL INDUSTRY.



BETADUCT ACCESSORIES

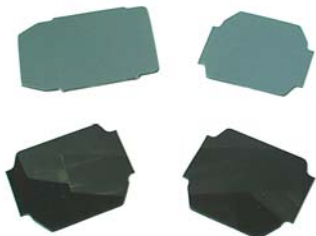

DIVIDERS

| BR.CAT.No | RSE.CAT.No. | DESCRIPTION | |
|-----------|-------------|-------------|--|
| | 10450009 | 50mm GREY | |
| | 10450010 | 75mm GREY | |
| | 1039 | 50mm BLACK | |
| | 1040 | 75mm BLACK | |

END PLATES

| BR.CAT.No | RSE.CAT.No. | DESCRIPTION | |
|-----------|-------------|-----------------------------|--|
| | R-EPG2550 | 25mm x 50mm STANDARD GREY | |
| | R-EPRG2550 | 25mm x 50mm RETAINING GREY | |
| | R-EPG2575 | 25mm x 75mm STANDARD GREY | |
| | R-EPRG2575 | 25mm x 75mm RETAINING GREY | |
| | R-EPG5050 | 50mm x 50mm STANDARD GREY | |
| | R-EPRG5050 | 50mm x 50mm RETAINING GREY | |
| | R-EPG5075 | 50mm x 75mm STANDARD GREY | |
| | R-EPRG5075 | 50mm x 75mm RETAINING GREY | |
| | R-EPG7575 | 75mm x 75mm STANDARD GREY | |
| | R-EPRG7575 | 75mm x 75mm RETAINING GREY | |
| | | | |
| | R-EPSB2550 | 25mm x 50mm STANDARD BLACK | |
| | R-EPRB2550 | 25mm x 50mm RETAINING BLACK | |
| | R-EPSB2575 | 25mm x 75mm STANDARD BLACK | |
| | R-EPRB2575 | 25mm x 75mm RETAINING BLACK | |
| | R-EPSB5050 | 50mm x 50mm STANDARD BLACK | |
| | R-EPRB5050 | 50mm x 50mm RETAINING BLACK | |
| | R-EPSB5075 | 50mm x 75mm STANDARD BLACK | |
| | R-EPRB5075 | 50mm x 75mm RETAINING BLACK | |
| | R-EPSB7575 | 75mm x 75mm STANDARD BLACK | |
| | R-EPRB7575 | 75mm x 75mm RETAINING BLACK | |

For price and delivery contact sales.

TEL:- (01782) 575316 FAX:- (01782) 834201 E-MAIL:- rseltd@btconnect.com

R.S.ELECTRICAL (RSE) LTD.

SPECIALIST SUPPLIERS TO THE RAIL INDUSTRY.

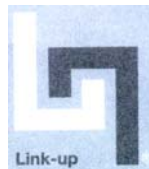

BETADUCT ACCESSORIES

GROMMET STRIP



| BR.CAT.No | RSE.CAT.No. | DESCRIPTION | |
|-----------|-------------|-----------------|--|
| | CC0495 | SIZE 3 SMOOTH | |
| | CC0496 | SIZE 4 SMOOTH | |
| | CC0497 | SIZE 5 SMOOTH | |
| | HELGP51A | SIZE 3 SERRATED | |
| | HELGP51B | SIZE 4 SERRATED | |
| | HELGP51C | SIZE 5 SERRATED | |

SPIROBAND



| BR.CAT.No | RSE.CAT.No. | SIZE | |
|-----------|-------------|-----------------|--|
| | CC0201 | Size 3 Natural | |
| | CC0205 | Size 6 Natural | |
| | CC0209 | Size 12 Natural | |

MISCELLANEOUS

| BR.CAT.No | RSE.CAT.No. | DESCRIPTION | |
|-----------|-------------|--------------|--|
| | RAVE1858 | RIVETER | |
| | RAVE1050 | RIVETS | |
| | RAVE1857 | SIDE CUTTERS | |

For price and delivery contact sales.

TEL:- (01782) 575316 FAX:- (01782) 834201 E-MAIL:- rseltd@btconnect.com

R.S.ELECTRICAL (RSE) LTD.

SPECIALIST SUPPLIERS TO THE RAIL INDUSTRY.



EGA HEAVY DUTY PLAIN CABLE DUCTING

| BR.CAT.No | RSE.CAT.No. | DESCRIPTION | |
|-----------|-------------|-------------------------|--|
| | STCCLT1 | 50mm WIDE x 50mm HIGH | |
| | STCCLT2 | 75mm WIDE x 50mm HIGH | |
| | STCCLT3 | 75mm WIDE x 75mm HIGH | |
| | STCCLT4 | 100mm WIDE x 50mm HIGH | |
| | STCCLT6 | 100mm WIDE x 100mm HIGH | |
| | STCCLT8 | 150mm WIDE x 100mm HIGH | |
| | STCCLT9 | 150mm WIDE x 150mm HIGH | |

* Please State Colour (GREY or WHITE) when Ordering.

Please Note:- This Tray and Ducting is as used in REB's, and there are a number of accessories available including Angles, T-Pieces End Caps, Couplers etc. Contact us for Details.

For price and delivery contact sales.

TEL:- (01782) 575316 FAX:- (01782) 834201 E-MAIL:- rseltd@btconnect.com

R.S.ELECTRICAL (RSE) LTD.

SPECIALIST SUPPLIERS TO THE RAIL INDUSTRY.

HEAVY DUTY PVC CABLE TRAY AND ACCESSORIES



| BR.CAT.No | RSE.CAT.No. | DESCRIPTION | |
|------------------|--------------------|-----------------------------------|--|
| | MT300/100 | 300mm W x 100mm H Cable Tray | |
| | MT310 | Lid to Suit | |
| | ME300-10 | 90deg. Ext.Riser + Cover (MEC310) | |
| | MI300-10 | 90deg. Int.Riser + Cover (MEC310) | |
| | MA300-10 | Flat Bend 90deg. + Cover (MEC310) | |
| | MTT1 | Tee Piece and Crossover | |
| | SS316 | Nuts Bolts and Washers | |
| | MCC100 | Coupler | |
| | MHB300 | Horizontal Mounting Brackets | |

Other sizes available contact us for details.

For price and delivery contact sales.

TEL:- (01782) 575316 FAX:- (01782) 834201 E-MAIL:-rseltd@btconnect.com

R.S.ELECTRICAL (RSE) LTD.

SPECIALIST SUPPLIERS TO THE RAIL INDUSTRY.

HEAVY DUTY GRP CABLE TRAY AND ACCESSORIES



3 METRE STRAIGHT LENGTH WITH LID/COVER

| BR.CAT.No | RSE.CAT.No. | DESCRIPTION | |
|-----------|--------------|-----------------|--|
| | GRP150-110/C | 110 DEEP SERIES | |
| | GRP150-210/C | 210 DEEP SERIES | |

1500 RADII FLAT ANGLE WITH LID/COVER 110 DEEP SERIES

| BR.CAT.No | RSE.CAT.No. | DESCRIPTION | |
|-----------|---------------|-----------------|--|
| | GRA15-11/C-12 | 10 DEGREE ANGLE | |
| | GRA15-11/C-34 | 30 DEGREE ANGLE | |
| | GRA15-11/C-56 | 50 DEGREE ANGLE | |
| | GRA15-11/C-78 | 70 DEGREE ANGLE | |
| | GRA15-11/C-90 | 90 DEGREE ANGLE | |

1500 RADII INTERNAL RISER ANGLE WITH LID/COVER 110 DEEP SERIES

| BR.CAT.No | RSE.CAT.No. | DESCRIPTION | |
|-----------|---------------|-----------------|--|
| | GRI15-11/C-12 | 10 DEGREE ANGLE | |
| | GRI15-11/C-34 | 30 DEGREE ANGLE | |
| | GRI15-11/C-56 | 50 DEGREE ANGLE | |
| | GRI15-11/C-78 | 70 DEGREE ANGLE | |
| | GRI15-11/C-90 | 90 DEGREE ANGLE | |

1500 RADII EXTERNAL RISER ANGLE WITH LID/COVER 110 DEEP SERIES

| BR.CAT.No | RSE.CAT.No. | DESCRIPTION | |
|-----------|---------------|-----------------|--|
| | GRE15-11/C-12 | 10 DEGREE ANGLE | |
| | GRE15-11/C-34 | 30 DEGREE ANGLE | |
| | GRE15-11/C-56 | 50 DEGREE ANGLE | |
| | GRE15-11/C-78 | 70 DEGREE ANGLE | |
| | GRE15-11/C-90 | 90 DEGREE ANGLE | |

1500 RADII INTERNAL RISER ADAPTER WITH LID/COVER 110 DEEP SERIES

| BR.CAT.No | RSE.CAT.No. | DESCRIPTION | |
|-----------|---------------------|-----------------|--|
| | GRIACT19-15-11/C-34 | 30 DEGREE ANGLE | |

1500 RADII STRAIGHT REDUCER WITH LID/COVER

| BR.CAT.No | RSE.CAT.No. | DESCRIPTION | |
|-----------|------------------|-------------|--|
| | GR15-21/15-11T/C | TOP LEVEL | |
| | GR15-21/15-11B/C | BASE LEVEL | |

For price and delivery contact sales.

TEL:- (01782) 575316 FAX:- (01782) 834201 E-MAIL:- rseltd@btconnect.com

R.S.ELECTRICAL (RSE) LTD.

SPECIALIST SUPPLIERS TO THE RAIL INDUSTRY.

MITA GRP ELEVATED CABLE TROUGHING **AND ACCESSORIES**



| BR.CAT.No | RSE.CAT.No. | DIMENSIONS WxH | EQUIV.CONCRETE SIZE | |
|------------------|--------------------|---------------------------|--------------------------------|--|
| | GRP100-6/NS/C | 100x60 | | |
| | GRP100-8/NS/C | 100x80 | | |
| | GRP100-110/NS/C | 100x110 | C/1/16 | |
| | GRP150-6/NS/C | 150x60 | | |
| | GRP150-8/NS/C | 150x80 | | |
| | GRP150-110/NS/C | 150x110 | C/1/17 | |
| | GRP150-210/NS/C | 150x210 | C/1/18 | |
| | GRP200-6/NS/C | 200x60 | | |
| | GRP200-8/NS/C | 200x80 | | |
| | GRP200-110/NS/C | 200x110 | C/1/19 | |
| | GRP300-6/NS/C | 300x60 | | |
| | GRP300-8/NS/C | 300x80 | | |
| | GRP300-110/NS/C | 300x110 | C/1/10 | |
| | GRP400-8/NS/C | 400x80 | | |
| | GRP400-110/NS/C | 400x100 | C/1/43 | |

For price and delivery contact sales.

TEL:- (01782) 575316 FAX:- (01782) 834201 E-MAIL:-rseltd@btconnect.com

R.S.ELECTRICAL (RSE) LTD.

SPECIALIST SUPPLIERS TO THE RAIL INDUSTRY.

STEEL CABLE TRAY AND ACCESSORIES



| BR.CAT.No | RSE.CAT.No. | DESCRIPTION | |
|-----------|------------------|--|--|
| | STCMRFL75G(3") | Admiralty Tray (Hot Dip Galvanised Finish) | |
| | STCMRFC/G | Coupler (Pair) | |
| | STCSTB75/G | Stand Off Bracket | |
| | STCMRFB75/G | 90 Degree Flat Bend | |
| | STCMRFOR75/G | 90 Degree Outside Riser | |
| | STCMRFIR75/G | 90 Degree Inside Riser | |
| | STCMRFT75/G | Tee | |
| | STCMRFX75/G | 4 Way Cross Piece | |
| | | | |
| | STCMRFL150G(6") | Admiralty Tray (Hot Dip Galvanised Finish) | |
| | STCMRFC/G | Coupler (Pair) | |
| | STCSTB150/G | Stand Off Bracket | |
| | STCMRFB150/G | 90 Degree Flat Bend | |
| | STCMRFOR150/G | 90 Degree Outside Riser | |
| | STCMRFIR150/G | 90 Degree Inside Riser | |
| | STCMRFT150/G | Tee | |
| | STCMRFX150/G | 4 Way Cross Piece | |
| | | | |
| | STCMRFL225G(8") | Admiralty Tray (Hot Dip Galvanised Finish) | |
| | STCMRFC/G | Coupler (Pair) | |
| | STCSTB225/G | Stand Off Bracket | |
| | STCMRFB225/G | 90 Degree Flat Bend | |
| | STCMRFOR225/G | 90 Degree Outside Riser | |
| | STCMRFIR225/G | 90 Degree Inside Riser | |
| | STCMRFT225/G | Tee | |
| | STCMRFX225/G | 4 Way Cross Piece | |
| | | | |
| | STCMRFL300G(12") | Admiralty Tray (Hot Dip Galvanised Finish) | |
| | STCMRFC/G | Coupler (Pair) | |
| | STCSTB300/G | Stand Off Bracket | |
| | STCMRFB300/G | 90 Degree Flat Bend | |
| | STCMRFOR300/G | 90 Degree Outside Riser | |
| | STCMRFIR300/G | 90 Degree Inside Riser | |
| | STCMRFT300/G | Tee | |
| | STCMRFX300/G | 4 Way Cross Piece | |

For price and delivery contact sales.

TEL:- (01782) 575316 FAX:- (01782) 834201 E-MAIL:-rseltd@btconnect.com

R.S.ELECTRICAL (RSE) LTD.

SPECIALIST SUPPLIERS TO THE RAIL INDUSTRY.

STEEL CABLE TRAY AND ACCESSORIES



| BR.CAT.No | RSE.CAT.No. | DESCRIPTION | |
|------------------|--------------------|--|--|
| | STCMRFL450G(18") | Admiralty Tray (Hot Dip Galvanised Finish) | |
| | STCMRFC/G | Coupler | |
| | STCSTB450/G | Stand Off Bracket | |
| | STCMRFB450/G | 90 Degree Flat Bend | |
| | STCMRFOR450/G | 90 Degree Outside Riser | |
| | STCMRFIR450/G | 90 Degree Inside Riser | |
| | STCMRFT450/G | Tee | |
| | STCMRFX450/G | 4 Way Cross Piece | |
| | STCSBZRB69 | 12mm BZP Roofing Nut & Bolt | |
| | STCSBZRB70 | 16mm BZP Roofing Nut & Bolt | |
| | | Hilti Fixings Available on Request | |

WE CAN SUPPLY TRAY IN:-
PRE-GALVANISED (INDOOR USE),
POST GALVANISED (OUTDOOR USE),
DEEP GALVANISED (AREAS OF HIGH MOISTURE INGRESS),
MEDIUM DUTY (PLATFORMS ETC.,)
HEAVY DUTY,
EXTRA HEAVY DUTY (AS USED ON THE CHANNEL TUNNEL.)

For price and delivery contact sales.

TEL:- (01782) 575316 FAX:- (01782) 834201 E-MAIL:-rseltd@btconnect.com

R.S.ELECTRICAL (RSE) LTD.

SPECIALIST SUPPLIERS TO THE RAIL INDUSTRY.



PMA CONDUIT AND FITTINGS

| BR.CAT.No | RSE.CAT.No. | DESCRIPTION | |
|-----------|--------------|-------------|--|
| | PMA CPLT-10* | 12mm | |
| | PMA CPLT-12* | 16mm | |
| | PMA CPLT-17* | 20mm | |
| | PMA CPLT-23* | 25mm | |
| | PMA CPLT-29* | 32mm | |

Straight Fittings

| BR.CAT.No | RSE.CAT.No. | DESCRIPTION | |
|-----------|----------------|-------------|--|
| | PMA*FND2F-PO90 | 12mm/PG9 | |
| | PMA*FND2F-M162 | 16mm/16mm | |
| | PMA*FND2F-M207 | 20mm/20mm | |
| | PMA*FND2F-M253 | 25mm/25mm | |
| | PMA*FND2F-M329 | 32mm/32mm | |

Angle Fittings

| BR.CAT.No | RSE.CAT.No. | DESCRIPTION | |
|-----------|-----------------|-------------|--|
| | PMA*BFWD2F-PO90 | 12mm/PG9 | |
| | PMA*BFWD2F-M162 | 16mm/16mm | |
| | PMA*BFWD2F-M207 | 20mm/20mm | |
| | PMA*BFWD2F-M253 | 25mm/25mm | |
| | PMA*BFWD2F-M329 | 32mm/32mm | |

Please Indicate Colour by substituting B for Black or S for Grey for the *

For price and delivery contact sales.

TEL:- (01782) 575316 FAX:- (01782) 834201 E-MAIL:- rseltd@btconnect.com

R.S.ELECTRICAL (RSE) LTD.

SPECIALIST SUPPLIERS TO THE RAIL INDUSTRY.



PMA ZERO HALOGEN CONDUITS

| BR.CAT.No | RSE.CAT.No. | DESCRIPTION | |
|-----------|-------------|-------------|--|
| | VAMLT-10* | 12mm | |
| | VAMLT-12* | 16mm | |
| | VAMLT-17* | 20mm | |
| | VAMLT-23* | 25mm | |
| | VAMLT-29* | 32mm | |

Straight Fittings

| BR.CAT.No | RSE.CAT.No. | DESCRIPTION | |
|-----------|-------------|-------------|--|
| | *VND-M160GT | 12mm | |
| | *VND-M162GT | 16mm | |
| | *VND-M207GT | 20mm | |
| | *VND-M253GT | 25mm | |
| | *VND-M329GT | 32mm | |

90 Degree Angle Fittings

| BR.CAT.No | RSE.CAT.No. | DESCRIPTION | |
|-----------|-------------|-------------|--|
| | *VWD-M160GT | 12mm | |
| | *VWD-M162GT | 16mm | |
| | *VWD-M207GT | 20mm | |
| | *VWD-M253GT | 25mm | |
| | *VWD-M329GT | 32mm | |

45 Degree Angle Fittings

| BR.CAT.No | RSE.CAT.No. | DESCRIPTION | |
|-----------|-------------|-------------|--|
| | *VAD-M160GT | 12mm | |
| | *VAD-M162GT | 16mm | |
| | *VAD-M207GT | 20mm | |
| | *VAD-M253GT | 25mm | |
| | *VAD-M329GT | 32mm | |

Please Indicate Colour by substituting B for Black or S for Grey for the *

For price and delivery contact sales.

TEL:- (01782) 575316 FAX:- (01782) 834201 E-MAIL:-rseltd@btconnect.com

R.S.ELECTRICAL (RSE) LTD.

SPECIALIST SUPPLIERS TO THE RAIL INDUSTRY.



SECTION 10 **IDENTIFICATION**

RS ELECTRICAL CARRY THE FULL RANGE OF CABLE MARKER (BEADS),
APPLICATORS, FLEXIMARK AND ANGLE STRIP ALL AVAILABLE FOR
SAME DAY DESPATCH.

- PAGE 1-4. SIZE 9-18 CABLE MARKERS.
- PAGE 5. SPECIAL MARKERS.
- PAGE 6. FLEXIMARK CABLE CARRIERS, MARKER APPLICATORS.
CABLE MARKER STORAGE BOXES.

For price and delivery contact sales.

TEL:- (01782) 575316 FAX:- (01782) 834201 E-MAIL:- rseltd@btconnect.com

[Return to top](#)

R.S.ELECTRICAL (RSE) LTD.

SPECIALIST SUPPLIERS TO THE RAIL INDUSTRY.



Cable Markers (Beads)



| BR.CAT.No | RSE.CAT.No. | DESCRIPTION | |
|-----------|--------------|-----------------|--|
| 54/111895 | TYCO0615 - 1 | Size 9 Number 1 | |
| 54/111896 | TYCO0615 - 2 | Size 9 Number 2 | |
| 54/111897 | TYCO0615 - 3 | Size 9 Number 3 | |
| 54/111898 | TYCO0615 - 4 | Size 9 Number 4 | |
| 54/111899 | TYCO0615 - 5 | Size 9 Number 5 | |
| 54/111900 | TYCO0615 - 6 | Size 9 Number 6 | |
| 54/111901 | TYCO0615 - 7 | Size 9 Number 7 | |
| 54/111902 | TYCO0615 - 8 | Size 9 Number 8 | |
| 54/111903 | TYCO0615 - 9 | Size 9 Number 9 | |
| 54/111904 | TYCO0615 - 0 | Size 9 Number 0 | |
| 54/111905 | TYCO0615 - A | Size 9 Letter A | |
| 54/111906 | TYCO0615 - B | Size 9 Letter B | |
| 54/111907 | TYCO0615 - C | Size 9 Letter C | |
| 54/111908 | TYCO0615 - D | Size 9 Letter D | |
| 54/111909 | TYCO0615 - E | Size 9 Letter E | |
| 54/111910 | TYCO0615 - F | Size 9 Letter F | |
| 54/111911 | TYCO0615 - G | Size 9 Letter G | |
| 54/111912 | TYCO0615 - H | Size 9 Letter H | |
| 54/111913 | TYCO0615 - I | Size 9 Letter I | |
| 54/111914 | TYCO0615 - J | Size 9 Letter J | |
| 54/111915 | TYCO0615 - K | Size 9 Letter K | |
| 54/111916 | TYCO0615 - L | Size 9 Letter L | |
| 54/111917 | TYCO0615 - M | Size 9 Letter M | |
| 54/111918 | TYCO0615 - N | Size 9 Letter N | |
| 54/111919 | TYCO0615 - O | Size 9 Letter O | |
| 54/111920 | TYCO0615 - P | Size 9 Letter P | |
| 54/111921 | TYCO0615 - Q | Size 9 Letter Q | |
| 54/111922 | TYCO0615 - R | Size 9 Letter R | |
| 54/111923 | TYCO0615 - S | Size 9 Letter S | |
| 54/111924 | TYCO0615 - T | Size 9 Letter T | |
| 54/111925 | TYCO0615 - U | Size 9 Letter U | |
| 54/111926 | TYCO0615 - V | Size 9 Letter V | |
| 54/111927 | TYCO0615 - W | Size 9 Letter W | |
| 54/111928 | TYCO0615 - X | Size 9 Letter X | |
| 54/111929 | TYCO0615 - Y | Size 9 Letter Y | |
| 54/111930 | TYCO0615 - Z | Size 9 Letter Z | |

For price and delivery contact sales.

TEL:- (01782) 575316 FAX:- (01782) 834201 E-MAIL:-rseltd@btconnect.com

R.S.ELECTRICAL (RSE) LTD.

SPECIALIST SUPPLIERS TO THE RAIL INDUSTRY.



Cable Markers (Beads)

| BR.CAT.No | RSE.CAT.No. | DESCRIPTION | |
|-----------|------------------|------------------|--|
| 54/111931 | TYCO0615 - Plus | Size 9 Marked + | |
| 54/111932 | TYCO0615 - Minus | Size 9 Marked - | |
| 54/111933 | TYCO0615 - / | Size 9 Marked / | |
| | | | |
| 86/011100 | TYCO0617 - 1 | Size 13 Number 1 | |
| 86/011101 | TYCO0617 - 2 | Size 13 Number 2 | |
| 86/011102 | TYCO0617 - 3 | Size 13 Number 3 | |
| 86/011103 | TYCO0617 - 4 | Size 13 Number 4 | |
| 86/011104 | TYCO0617 - 5 | Size 13 Number 5 | |
| 86/011105 | TYCO0617 - 6 | Size 13 Number 6 | |
| 86/011106 | TYCO0617 - 7 | Size 13 Number 7 | |
| 86/011107 | TYCO0617 - 8 | Size 13 Number 8 | |
| 86/011108 | TYCO0617 - 9 | Size 13 Number 9 | |
| 86/011109 | TYCO0617 - 0 | Size 13 Number 0 | |
| 86/011110 | TYCO0617 - A | Size 13 Letter A | |
| 86/011111 | TYCO0617 - B | Size 13 Letter B | |
| 86/011112 | TYCO0617 - C | Size 13 Letter C | |
| 86/011113 | TYCO0617 - D | Size 13 Letter D | |
| 86/011114 | TYCO0617 - E | Size 13 Letter E | |
| 86/011115 | TYCO0617 - F | Size 13 Letter F | |
| 86/011116 | TYCO0617 - G | Size 13 Letter G | |
| 86/011117 | TYCO0617 - H | Size 13 Letter H | |
| 86/011118 | TYCO0617 - I | Size 13 Letter I | |
| 86/011119 | TYCO0617 - J | Size 13 Letter J | |
| 86/011120 | TYCO0617 - K | Size 13 Letter K | |
| 86/011121 | TYCO0617 - L | Size 13 Letter L | |
| 86/011122 | TYCO0617 - M | Size 13 Letter M | |
| 86/011123 | TYCO0617 - N | Size 13 Letter N | |
| 86/011124 | TYCO0617 - O | Size 13 Letter O | |
| 86/011125 | TYCO0617 - P | Size 13 Letter P | |
| 86/011126 | TYCO0617 - Q | Size 13 Letter Q | |
| 86/011127 | TYCO0617 - R | Size 13 Letter R | |
| 86/011128 | TYCO0617 - S | Size 13 Letter S | |
| 86/011129 | TYCO0617 - T | Size 13 Letter T | |
| 86/011130 | TYCO0617 - U | Size 13 Letter U | |
| 86/011131 | TYCO0617 - V | Size 13 Letter V | |
| 86/011132 | TYCO0617 - W | Size 13 Letter W | |
| 86/011133 | TYCO0617 - X | Size 13 Letter X | |
| 86/011134 | TYCO0617 - Y | Size 13 Letter Y | |
| 86/011135 | TYCO0617 - Z | Size 13 Letter Z | |
| 86/011136 | TYCO0617 - PLUS | Size 13 Marked + | |
| 86/011137 | TYCO0617 - MINUS | Size 13 Marked - | |
| 86/011138 | TYCO0617 - / | Size 13 Marked / | |
| | | | |

For price and delivery contact sales.

TEL:- (01782) 575316 FAX:- (01782) 834201 E-MAIL:- rseltd@btconnect.com

R.S.ELECTRICAL (RSE) LTD.

SPECIALIST SUPPLIERS TO THE RAIL INDUSTRY.



Cable Markers (Beads)

| BR.CAT.No | RSE.CAT.No. | DESCRIPTION | |
|-----------|------------------|------------------|--|
| 86/011160 | TYCO0618 - 1 | Size 15 Number 1 | |
| 86/011161 | TYCO0618 - 2 | Size 15 Number 2 | |
| 86/011162 | TYCO0618 - 3 | Size 15 Number 3 | |
| 86/011163 | TYCO0618 - 4 | Size 15 Number 4 | |
| 86/011164 | TYCO0618 - 5 | Size 15 Number 5 | |
| 86/011165 | TYCO0618 - 6 | Size 15 Number 6 | |
| 86/011166 | TYCO0618 - 7 | Size 15 Number 7 | |
| 86/011167 | TYCO0618 - 8 | Size 15 Number 8 | |
| 86/011168 | TYCO0618 - 9 | Size 15 Number 9 | |
| 86/011169 | TYCO0618 - 0 | Size 15 Number 0 | |
| 86/011190 | TYCO0618 - A | Size 15 Letter A | |
| 86/011191 | TYCO0618 - B | Size 15 Letter B | |
| 86/011192 | TYCO0618 - C | Size 15 Letter C | |
| 86/011193 | TYCO0618 - D | Size 15 Letter D | |
| 86/011201 | TYCO0618 - E | Size 15 Letter E | |
| 86/011194 | TYCO0618 - F | Size 15 Letter F | |
| 86/011182 | TYCO0618 - G | Size 15 Letter G | |
| 86/011183 | TYCO0618 - H | Size 15 Letter H | |
| 86/011202 | TYCO0618 - I | Size 15 Letter I | |
| 86/011184 | TYCO0618 - J | Size 15 Letter J | |
| 86/011185 | TYCO0618 - K | Size 15 Letter K | |
| 86/011195 | TYCO0618 - L | Size 15 Letter L | |
| 86/011186 | TYCO0618 - M | Size 15 Letter M | |
| 86/011196 | TYCO0618 - N | Size 15 Letter N | |
| 86/011187 | TYCO0618 - O | Size 15 Letter O | |
| 86/011188 | TYCO0618 - P | Size 15 Letter P | |
| 86/011189 | TYCO0618 - Q | Size 15 Letter Q | |
| 86/011197 | TYCO0618 - R | Size 15 Letter R | |
| 86/011204 | TYCO0618 - S | Size 15 Letter S | |
| 86/011198 | TYCO0618 - T | Size 15 Letter T | |
| 86/011205 | TYCO0618 - U | Size 15 Letter U | |
| 86/011206 | TYCO0618 - V | Size 15 Letter V | |
| 86/011207 | TYCO0618 - W | Size 15 Letter W | |
| 86/011203 | TYCO0618 - X | Size 15 Letter X | |
| 86/011208 | TYCO0618 - Y | Size 15 Letter Y | |
| 86/011209 | TYCO0618 - Z | Size 15 Letter Z | |
| 86/011199 | TYCO0618 - PLUS | Size 15 Marked + | |
| 86/011200 | TYCO0618 - MINUS | Size 15 Marked - | |

For price and delivery contact sales.

TEL:- (01782) 575316 FAX:- (01782) 834201 E-MAIL:- rseltd@btconnect.com

R.S.ELECTRICAL (RSE) LTD.

SPECIALIST SUPPLIERS TO THE RAIL INDUSTRY.



Cable Markers (Beads)

| BR.CAT.No | RSE.CAT.No. | DESCRIPTION | |
|------------------|--------------------|--------------------|--|
| 86/11170 | TYCO0620 - 0 | Size 18 Number 0 | |
| 86/11171 | TYCO0620 - 1 | Size 18 Number 1 | |
| 86/11172 | TYCO0620 - 2 | Size 18 Number 2 | |
| 86/11173 | TYCO0620 - 3 | Size 18 Number 3 | |
| 86/11174 | TYCO0620 - 4 | Size 18 Number 4 | |
| 86/11175 | TYCO0620 - 5 | Size 18 Number 5 | |
| 86/11176 | TYCO0620 - 6 | Size 18 Number 6 | |
| 86/11177 | TYCO0620 - 7 | Size 18 Number 7 | |
| 86/11178 | TYCO0620 - 8 | Size 18 Number 8 | |
| 86/11179 | TYCO0620 - 9 | Size 18 Number 9 | |
| 86/11210 | TYCO0620 - A | Size 18 Letter A | |
| 86/11211 | TYCO0620 - B | Size 18 Letter B | |
| 86/11212 | TYCO0620 - C | Size 18 Letter C | |
| 86/11213 | TYCO0620 - D | Size 18 Letter D | |
| 86/11221 | TYCO0620 - E | Size 18 Letter E | |
| 86/11214 | TYCO0620 - F | Size 18 Letter F | |
| 86/11223 | TYCO0620 - G | Size 18 Letter G | |
| 86/11224 | TYCO0620 - H | Size 18 Letter H | |
| 86/11225 | TYCO0620 - I | Size 18 Letter I | |
| 86/11226 | TYCO0620 - J | Size 18 Letter J | |
| 86/11227 | TYCO0620 - K | Size 18 Letter K | |
| 86/11215 | TYCO0620 - L | Size 18 Letter L | |
| 86/11228 | TYCO0620 - M | Size 18 Letter M | |
| 86/11216 | TYCO0620 - N | Size 18 Letter N | |
| 86/11229 | TYCO0620 - O | Size 18 Letter O | |
| 86/11230 | TYCO0620 - P | Size 18 Letter P | |
| 86/11267 | TYCO0620 - Q | Size 18 Letter Q | |
| 86/11217 | TYCO0620 - R | Size 18 Letter R | |
| 86/11268 | TYCO0620 - S | Size 18 Letter S | |
| 86/11218 | TYCO0620 - T | Size 18 Letter T | |
| 86/11269 | TYCO0620 - U | Size 18 Letter U | |
| 86/11270 | TYCO0620 - V | Size 18 Letter V | |
| 86/11271 | TYCO0620 - W | Size 18 Letter W | |
| 86/11272 | TYCO0620 - X | Size 18 Letter X | |
| 86/11273 | TYCO0620 - Y | Size 18 Letter Y | |
| 86/11274 | TYCO0620 - Z | Size 18 Letter Z | |
| 86/11219 | TYCO0620 - PLUS | Size 18 Marked + | |
| 86/11220 | TYCO0620 - MINUS | Size 18 Marked - | |
| | | | |

For price and delivery contact sales.

TEL:- (01782) 575316 FAX:- (01782) 834201 E-MAIL:- rseltd@btconnect.com

R.S.ELECTRICAL (RSE) LTD.

SPECIALIST SUPPLIERS TO THE RAIL INDUSTRY.



Special Markers (Beads)

| BR.CAT.No | RSE.CAT.No. | DESCRIPTION | |
|-----------|-------------|---------------------------|--|
| 86/011231 | TYCO0618-R1 | Size 15 BK/WH Marked R1 | |
| 86/011232 | TYCO0618-R2 | Size 15 BK/WH Marked R2 | |
| 86/011233 | TYCO0618-R3 | Size 15 BK/WH Marked R3 | |
| 86/011234 | TYCO0618-R4 | Size 15 BK/WH Marked R4 | |
| | | | |
| 86/011235 | TYCO0618-A1 | Size 15 RED/WH Marked A1 | |
| 86/011236 | TYCO0618-A2 | Size 15 RED/WH Marked A2 | |
| 86/011237 | TYCO0618-A3 | Size 15 RED/WH Marked A3 | |
| 86/011238 | TYCO0618-A4 | Size 15 RED/WH Marked A4 | |
| 86/011239 | TYCO0618-A5 | Size 15 RED/WH Marked A5 | |
| 86/011240 | TYCO0618-A6 | Size 15 RED/WH Marked A6 | |
| 86/011241 | TYCO0618-A7 | Size 15 RED/WH Marked A7 | |
| 86/011242 | TYCO0618-A8 | Size 15 RED/WH Marked A8 | |
| | | | |
| 86/011243 | TYCO0618-B1 | Size 15 GRN/WH Marked B1 | |
| 86/011244 | TYCO0618-B2 | Size 15 GRN/WH Marked B2 | |
| 86/011245 | TYCO0618-B3 | Size 15 GRN/WH Marked B3 | |
| 86/011246 | TYCO0618-B4 | Size 15 GRN/WH Marked B4 | |
| 86/011247 | TYCO0618-B5 | Size 15 GRN/WH Marked B5 | |
| 86/011248 | TYCO0618-B6 | Size 15 GRN/WH Marked B6 | |
| 86/011249 | TYCO0618-B7 | Size 15 GRN/WH Marked B7 | |
| 86/011250 | TYCO0618-B8 | Size 15 GRN/WH Marked B8 | |
| | | | |
| 86/011251 | TYCO0618-C1 | Size 15 BLUE/WH Marked C1 | |
| 86/011252 | TYCO0618-C2 | Size 15 BLUE/WH Marked C2 | |
| 86/011253 | TYCO0618-C3 | Size 15 BLUE/WH Marked C3 | |
| 86/011254 | TYCO0618-C4 | Size 15 BLUE/WH Marked C4 | |
| 86/011255 | TYCO0618-C5 | Size 15 BLUE/WH Marked C5 | |
| 86/011256 | TYCO0618-C6 | Size 15 BLUE/WH Marked C6 | |
| 86/011257 | TYCO0618-C7 | Size 15 BLUE/WH Marked C7 | |
| 86/011258 | TYCO0618-C8 | Size 15 BLUE/WH Marked C8 | |
| | | | |
| 86/011259 | TYCO0618-D1 | Size 15 YEL/BLK Marked D1 | |
| 86/011260 | TYCO0618-D2 | Size 15 YEL/BLK Marked D2 | |
| 86/011261 | TYCO0618-D3 | Size 15 YEL/BLK Marked D3 | |
| 86/011262 | TYCO0618-D4 | Size 15 YEL/BLK Marked D4 | |
| 86/011263 | TYCO0618-D5 | Size 15 YEL/BLK Marked D5 | |
| 86/011264 | TYCO0618-D6 | Size 15 YEL/BLK Marked D6 | |
| 86/011265 | TYCO0618-D7 | Size 15 YEL/BLK Marked D7 | |
| 86/011266 | TYCO0618-D8 | Size 15 YEL/BLK Marked D8 | |

For price and delivery contact sales.

TEL:- (01782) 575316 FAX:- (01782) 834201 E-MAIL:- rseltd@btconnect.com

R.S.ELECTRICAL (RSE) LTD.

SPECIALIST SUPPLIERS TO THE RAIL INDUSTRY.

Fleximark Cable Carriers



| <u>BR.CAT.No</u> | <u>RSE.CAT.No.</u> | <u>DESCRIPTION</u> | |
|------------------|--------------------|-----------------------------|--|
| | BR.61739030 | CLEAR CABLE CARRIER | |
| | BR.61739043 | BLACK SELF ADHESIVE CARRIER | |
| | BR.61839010 | LABEL KIT | |
| | BR.61739020 | FLEXIMARK APPLICATOR | |



Cable Marker Applicators

| <u>BR.CAT.No</u> | <u>RSE.CAT.No.</u> | <u>DESCRIPTION</u> | |
|------------------|--------------------|--------------------|--|
| | TYCO1252 | SIZE 9 APPLICATOR | |
| | TYCO1254 | SIZE 13 APPLICATOR | |
| | TYCO1255 | SIZE 15 APPLICATOR | |
| | TYCO1256 | SIZE 18 APPLICATOR | |



Cable Marker Storage Box

| <u>BR.CAT.No</u> | <u>RSE.CAT.No.</u> | <u>DESCRIPTION</u> | |
|------------------|--------------------|--------------------------|--|
| | BR.RSE-10 | CABLE MARKER STORAGE BOX | |

Please Note we are able to stock these compartmentalised boxes with markers to fit your requirements, contact us for further details.

For price and delivery contact sales.

TEL:- (01782) 575316 FAX:- (01782) 834201 E-MAIL:- rseltd@btconnect.com

R.S.ELECTRICAL (RSE) LTD.

SPECIALIST SUPPLIERS TO THE RAIL INDUSTRY.



SECTION 11
HEAT SHRINK AND
SLEEVING PRODUCTS.

GrayBar

HILLTOP

WE CARRY LARGE STOCKS OF GENERAL HEATSHRINK PRODUCTS AND MANY OF THE GRAYBAR RANGE OF SPECIALIST RAILWAY PRODUCTS, WHICH ENABLES US IN MOST CASES, TO DELIVER TO YOU NEXT DAY, EITHER FROM OURSELVES OR DIRECT FROM GRAYBAR.

CONTACT US WITH YOUR BR CATALOGUE NUMBER AND WE WILL BE ABLE TO SUPPLY YOU WITH THE CORRECT ITEM, AS THIS SECTION IS SO VAST WE ARE UNABLE TO SHOW EVERY ITEM. PLEASE CONTACT US FOR DETAILS.

- PAGE 1. HEAT SHRINK CABLE GLANDS AND CABLE END CAPS.
- PAGE 2. JOINTING KITS.
- PAGE 3. HEAT SHRINK TUBING, MOISTURE BARRIER KITS.
- PAGE 4. BRAIDED SLEEVING, CLEAR TUBING, RUBBER SLEEVING.
- PAGE 5. CABLE CLAMPS.
- PAGE 6. CABLE TIES AND BASES.

For price and delivery contact sales.

TEL:- (01782) 575316 FAX:- (01782) 834201 E-MAIL:-rseltd@btconnect.com

[Return to top](#)

R.S.ELECTRICAL (RSE) LTD.

SPECIALIST SUPPLIERS TO THE RAIL INDUSTRY.



HEAT SHRINK PRODUCTS



HEAT SHRINK CABLE GLANDS

| BR.CAT.No | RSE.CAT.No. | GLAND SIZE | |
|--------------|-------------|------------|--|
| BR.54/109179 | CES1 | 3mm-12mm | |
| BR.54/109175 | CES2 | 6mm-17mm | |
| BR.54/109176 | CES3 | 12mm-28mm | |
| BR.54/109164 | CES4 | 19mm-40mm | |
| BR.54/109181 | CES5 | 36mm-70mm | |

HEAT SHRINK CABLE END CAPS

| BR.CAT.No | RSE.CAT.No. | GLAND SIZE | |
|--------------|-------------|------------|--|
| BR.54/010716 | GB1612 | 10mm-4mm | |
| BR.54/012054 | GB1613 | 18mm-9mm | |
| BR.54/012051 | GB1614 | 35mm-15mm | |
| BR.54/012052 | GB1615 | 60mm-25mm | |
| BR.54/012053 | GB1616 | 72mm-30mm | |
| BR.54/012055 | GB1617 | 85mm-47mm | |

For price and delivery contact sales.

TEL:- (01782) 575316 FAX:- (01782) 834201 E-MAIL:-rseltd@btconnect.com

R.S.ELECTRICAL (RSE) LTD.

SPECIALIST SUPPLIERS TO THE RAIL INDUSTRY.



Jointing Kits

| BR.CAT.No. | RSE.CAT.No. | DESCRIPTION | |
|----------------|-------------|--------------------------------------|--|
| BR.54/015891 | GBK1085 | 2 CORE 35mm JOINT KIT | |
| BR.54/015893 | GBK1087 | 2 CORE 70mm JOINT KIT | |
| BR.54/015879 | GBK1088 | 2CORE 95mm JOINT KIT | |
| BR.86/044017 | GBK1142 | TRACK CIRCUIT BOND KIT, MOULDED ENDS | |
| BR.54/037125 | GBK1265 | 10 CORE JOINTING KIT | |
| BR.54/037123 | GBK1278 | 27 CORE JOINTING KIT | |
| BR.55/120991 | GBK2001 | TRACK CIRCUIT RAIL BOND TUBE | |
| BR.86/044019 | GBK2002 | TRACK CIRCUIT BOND KIT | |
| BR.54/015870/1 | GBK2007 | 12-19 CORE JOINT KIT | |
| BR.54/015872/4 | GBK2008 | 27-37 CORE JOINT KIT | |
| BR.54/036101 | GBK2061 | 2 CORE TRACK CIRCUIT JOINT KIT | |
| BR.54/036102 | GBK2062 | 4xSINGLE, 1x2 CORE TRACK JOINT KIT | |
| BR.54/036125 | GBK2087 | 4 CORE 70mm JOINT KIT | |

For price and delivery contact sales.

TEL:- (01782) 575316 FAX:- (01782) 834201 E-MAIL:- rseltd@btconnect.com

R.S.ELECTRICAL (RSE) LTD.

SPECIALIST SUPPLIERS TO THE RAIL INDUSTRY.



HEAT SHRINK TUBING

| BR.CAT.No | RSE.CAT.No. | REDUCTION SIZE-LENGTH | |
|-----------|---------------|-----------------------|--|
| | BR.HSP1-1.2* | 1.2mm-0.6mm x 15M | |
| | BR.HSP1-1.6* | 1.6mm-0.8mm x 15M | |
| | BR.HSP1-2.4* | 2.4mm-1.2mm x 15M | |
| | BR.HSP1-3.2* | 3.2mm-1.6mm x 15M | |
| | BR.HSP1-4.8* | 4.8mm-2.4mm x 15M | |
| | BR.HSP1-6.4* | 6.4mm-3.2mm x 10M | |
| | BR.HSP1-9.5* | 9.5mm-4.7mm x 10M | |
| | BR.HSP1-12.7* | 12.7mm-6.4mm x 8M | |
| | BR.HSP1-19.1* | 19.1mm-9.5mm x 7M | |
| | BR.HSP1-25.4* | 25.4mm-12.7mm x 4M | |
| | BR.HSP1-38.1* | 38.1mm-19.1mm x 30M | |

Please State Colour when Ordering. Standard Colours

Available are BLACK, RED, YELLOW, BLUE, GREEN, CLEAR, AND GREEN/
YELLOW.

MOISTURE BARRIER KITS

| BR.CAT.No | RSE.CAT.No. | DESCRIPTION | |
|-----------|-------------|--------------------|--|
| 54/037070 | GBK1138 | 6mm-14mm DIAMETER | |
| 54/037052 | GBK1139 | 13mm-24mm DIAMETER | |
| 54/037053 | GBK1140 | 20mm-37mm DIAMETER | |
| 54/037054 | GBK1141 | 27mm-48mm DIAMETER | |

For price and delivery contact sales.

TEL:- (01782) 575316 FAX:- (01782) 834201 E-MAIL:- rseltd@btconnect.com

R.S.ELECTRICAL (RSE) LTD.

SPECIALIST SUPPLIERS TO THE RAIL INDUSTRY.



BRAIDED SLEEVING

| BR.CAT.No | RSE.CAT.No. | DIAMETER SIZE | |
|-----------|-------------|---------------|--|
| | VSR10-2 | 2mm | |
| | VSR10-4 | 4mm | |
| | VSR10-6 | 6mm | |
| | VSR10-10 | 10mm | |
| | VSR10-16 | 16mm | |

CLEAR TUBING

| BR.CAT.No | RSE.CAT.No. | SIZE | |
|-----------|-------------|--------------|--|
| | FE30X5MTNL | 3mm x 5M Lg. | |



RUBBER SLEEVING

| BR.CAT.No | RSE.CAT.No. | SIZE | |
|-----------|-------------|----------------|--|
| | H30X25 | 3mm x 25mm Lg. | |
| | H50X25 | 5mm x 25mm Lg. | |

For price and delivery contact sales.

TEL:- (01782) 575316 FAX:- (01782) 834201 E-MAIL:- rseltd@btconnect.com

R.S.ELECTRICAL (RSE) LTD.

SPECIALIST SUPPLIERS TO THE RAIL INDUSTRY.

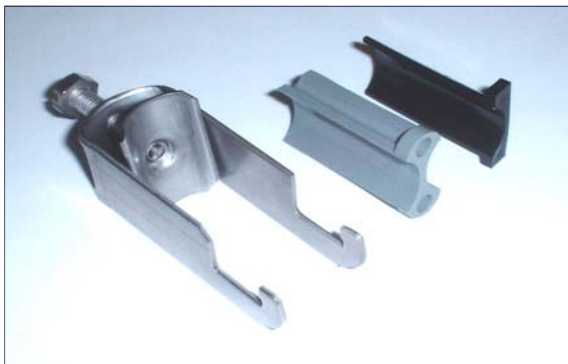

CABLE CLAMPS

| BR.CAT.No | RSE.CAT.No. | CABLE SIZE | |
|------------------|--------------------|------------------------------|--|
| BR.86/043600 | | For 1 Cable to Rack 12-16mm | |
| BR.86/043601 | | For 1 Cable to Rack 16-20mm | |
| BR.86/043602 | | For 1 Cable to Rack 20-24mm | |
| BR.86/043603 | | For 1 Cable to Rack 24-28mm | |
| BR.86/043604 | | For 1 Cable to Rack 28-32mm | |
| BR.86/043605 | | For 1 Cable to Rack 32-36mm | |
| BR.86/043606 | | For 2 Cables to Rack 12-16mm | |
| BR.86/043607 | | For 2 Cables to Rack 16-20mm | |
| BR.86/043608 | | For 2 Cables to Rack 20-24mm | |
| BR.86/043609 | | For 2 Cables to Rack 24-28mm | |
| BR.86/043610 | | For 2 Cables to Rack 32-36mm | |

For price and delivery contact sales.

TEL:- (01782) 575316 FAX:- (01782) 834201 E-MAIL:-rseltd@btconnect.com

R.S.ELECTRICAL (RSE) LTD.

SPECIALIST SUPPLIERS TO THE RAIL INDUSTRY.



Hellerman Outside Serrated Cable Ties

| BR.CAT.No | RSE.CAT.No. | DESCRIPTION | |
|--------------|-------------|---------------------|--|
| BR.86/011150 | LK0X | 100mm x 2.3mm Black | |
| BR.86/011151 | LK0B | 200mm x 3.5mm Black | |
| BR.86/011152 | LK2C | 200mm x 4.6mm Black | |
| BR.86/011153 | LK2M | 260mm x 4.6mm Black | |
| BR.86/011154 | LK4 | 300mm x 7.6mm Black | |

Hellerman Cable Tie Bases

| BR.CAT.No | RSE.CAT.No. | DESCRIPTION | |
|-----------|-------------|---------------------------------|--|
| | MB3A/SA | For Cable Ties Up To 3.5mm Wide | |
| | MB4A/SA | For Cable Ties Up To 6.5mm Wide | |

Available In Black or Natural

For price and delivery contact sales.

TEL:- (01782) 575316 FAX:- (01782) 834201 E-MAIL:- rseltd@btconnect.com

R.S.ELECTRICAL (RSE) LTD.

SPECIALIST SUPPLIERS TO THE RAIL INDUSTRY.



SECTION 12 **TOOLS AND FIXINGS.**

Hilti RAIL PRODUCTS

THIS SECTION DEMONSTRATES THE LARGE SELECTION OF TOOLS AND FIXINGS AVAILABLE, MANY EX STOCK FOR SAME DAY / NEXT DAY DELIVERY.

PAGE 1-3. HILTI TOOLS AND FIXINGS

For price and delivery contact sales.

TEL:- (01782) 575316 FAX:- (01782) 834201 E-MAIL:-rseltd@btconnect.com

[Return to top](#)

R.S.ELECTRICAL (RSE) LTD.

SPECIALIST SUPPLIERS TO THE RAIL INDUSTRY.

Hilti Tools and Fixings



| BR.CAT.No | RSE. CAT.No | HILTI PRODUCT | DESCRIPTION | |
|------------|-------------|----------------------|-----------------------|--|
| 039/035019 | 282373 | PD30 LASER | LASER RANGE METER | |
| | | | | |
| 086/003209 | 334437 | TE6A | 36V BATTERY DRILL KIT | |
| 086/003210 | 332031 | BP6-86 BATTERY | BATTERY FOR TE6A | |
| 086/003211 | 332021 | TCU 7/36 (240V) | CHARGER FOR TE6A | |
| | | | | |
| 086/003219 | 228889 | TE15 (110V) TOOL | TE15 DRILLING MACHINE | |
| 086/003220 | 308332 | TE25 (110V) TOOL | TE25 DRILLING MACHINE | |
| | | | | |
| 094/004009 | 312474 | TE35 (110V) TOOL | TE35 ROTARY HAMMER | |
| | | | | |
| 039/001029 | 205304 | TECX 6/12 DRILL BIT | 6mm SDS DRILL BIT | |
| 039/012069 | 205315 | TECX 8/17 DRILL BIT | 8mm SDS DRILL BIT | |
| 055/103003 | 205317 | TECX 8/22 DRILL BIT | 8mm SDS DRILL BIT | |
| 039/001022 | 028002 | TECX18/22S DRILL BIT | 18mm SDS DRILL BIT | |
| 039/001020 | 028003 | TECX18/47S DRILL BIT | 18mm SDS DRILL BIT | |
| | | | | |
| 011/053165 | 248525 | HUD-1 6 | HUD-1 6 NYLON PLUG | |
| | | | | |
| 011/190215 | 230525 | HPS1R 6/10 x 35 | STAINLESS HAMMASCREW | |
| 035/018013 | 260360 | HPS1R 6/15 x 40 | STAINLESS HAMMASCREW | |
| 040/058397 | 260361 | HPS1R 6/25 x 50 | STAINLESS HAMMASCREW | |
| 035/103078 | 230516 | HPS1R 6/10 x 35 | HAMMASCREW 6mm | |
| 035/040435 | 260353 | HPS1R 8/10 x 40 | HAMMASCREW 8mm | |
| | | | | |
| 088/002545 | 246787 | FB13 CLIP | CLIP FOR 13mm CABLE | |
| 088/002548 | 053082 | FB20 CLIP | CLIP FOR 20mm CABLE | |
| 054/010336 | 054283 | SF12GA CLIP | CLIP FOR 12mm CABLE | |
| 054/010337 | 054285 | SF16GA CLIP | CLIP FOR 16mm CABLE | |
| 054/010338 | 054287 | SF20GA CLIP | CLIP FOR 20mm CABLE | |
| 054/011647 | 054289 | SF25GA CLIP | CLIP FOR 25mm CABLE | |
| 054/010339 | 053848 | SF32GA CLIP | CLIP FOR 32mm CABLE | |
| | | | | |
| 011/137001 | 058003 | M8 BZP WASHER | MILD STEEL WASHER | |
| | | | | |
| 011/190100 | 335507 | HLD3 FIXING | CAVITY ANCHOR | |
| | | | | |
| 011/052264 | 242869 | HKDS M10 ANCHOR | HKDS M10 x 40 | |
| 011/052265 | 242871 | HKDS M12 ANCHOR | HKDS M12 x 50 | |

For price and delivery contact sales.

TEL:- (01782) 575316 FAX:- (01782) 834201 E-MAIL:- rseltd@btconnect.com

R.S.ELECTRICAL (RSE) LTD.

SPECIALIST SUPPLIERS TO THE RAIL INDUSTRY.



Hilti Tools and Fixings

| BR.CAT.No | RSE. CAT.No | HILTI PRODUCT | DESCRIPTION | |
|------------|----------------|--------------------|-------------------------|--|
| 030/141007 | 255844 | HSA M12 x 80 | STUD ANCHOR | |
| 030/142610 | 229935 | HSA-K M12 x 150 | STUD ANCHOR | |
| 062/015052 | 332193 | HAS-KR M12 x 80 | STUD ANCHOR (TWPS) | |
| | | | | |
| 031/107035 | 045859 | HSL-TZ M12/25 ANC | HSL-TZ M12/25 | |
| 031/107036 | 066593 | HSL-3 M12/50 ANC | HSL M12 HEAVY DUTY | |
| 062/000024 | 371809 | HSL-3B M12/50 ANC | HSL-3-B M12/50 ANCHOR | |
| | | | | |
| 057/048292 | 216962 | HRS-22 | REHABILITATION SLEEVE | |
| | | | | |
| 007/051037 | 229156 | HILTI HIT HY20 | RESIN FOR HOLLOW MAT'L | |
| 007/051038 | 229157 | HILTI HIT HY50 | RESIN FOR MASONRY/BRICK | |
| 007/051039 | 315959 | HILTI HIT HY150 | RESIN FOR CONCRETE | |
| | | | | |
| 001/111020 | 034080 | RCW 356 x 4 x 25-P | 14" RAIL CUTTING DISK | |
| | | | | |
| 039/067580 | 000710 | DX450 TOOL | CARTRIDGE TOOL | |
| 039/054330 | 000733 | SPALL STOP 45/S4 | SPALL STOP | |
| | | | | |
| 027/020261 | 059082 | DX SPRAY | LUBRICANT 70cc | |
| | | | | |
| 039/005015 | 050351 | GREEN CARTRIDGE | 6.8/11M FOR DX450/DXA | |
| 039/005014 | 050352 | YELLOW CARTRIDGE | 6.8/11M FOR DX450/DXA | |
| 039/005652 | 050353 | RED CARTRIDGE | 6.8/11M FOR DX450/DXA | |
| 039/005653 | 050354 | BLACK CARTRIDGE | 6.8/11M FOR DX450/DXA | |
| | | | | |
| 030/043624 | 041058 | NK27S12 NAIL | NAIL FOR DX450 | |
| 030/043625 | 041059 | NK32S12 NAIL | NAIL FOR DX450 | |
| 030/043627 | 041061 | NK42S12 NAIL | NAIL FOR DX450 | |
| 030/043626 | 041070 | NK54S12 NAIL | NAIL FOR DX450 | |
| | | | | |
| 030/043623 | 041503 | ENK16S12 NAIL | NAIL FOR DX450 | |
| | | | | |
| 011/080002 | 306055 | M6-11-27D12 | M6 STUD FOR DX450 | |
| 011/080001 | 306101 | M8-20-32D12 | M8STUD FOR DX450 | |
| | | | | |
| 039/040054 | 000753 | 45/M6-11 PISTON | PISTON FOR M6 STUDS | |

For price and delivery contact sales.

TEL:- (01782) 575316 FAX:- (01782) 834201 E-MAIL:- rseltd@btconnect.com

R.S.ELECTRICAL (RSE) LTD.

SPECIALIST SUPPLIERS TO THE RAIL INDUSTRY.



Hilti Tools and Fixings

| BR.CAT.No | RSE.CAT.No | HILTI PRODUCT | DESCRIPTION | |
|------------|------------|-------------------|-----------------------|--|
| 040/000666 | 050501 | GREEN CARTRIDGE | 6.8/18 FOR DX600 | |
| 040/000665 | 050503 | RED CARTRIDGE | 6.8/18 FOR DX600 | |
| 039/005659 | 050404 | BLACK CARTRIDGE | 6.8/18 FOR DX600 | |
| | | | | |
| 040/057873 | 006611 | 6N/DSL PISTON | PISTON FOR DX600 | |
| | | | | |
| 030/043630 | 046161 | DS47P10 NAIL | NAIL FOR DX600/DX750 | |
| 030/043657 | 046165 | DS72P10 NAIL | NAIL FOR DX600/DX750 | |
| | | | | |
| 011/006130 | 065301 | EC2-4/6-7 CLIP | EDGE CLIP FOR GIRDERS | |
| 011/006131 | 065302 | EC2-4/8-9 CLIP | EDGE CLIP FOR GIRDERS | |
| 011/006132 | 065303 | EC2-4/10-11 CLIP | EDGE CLIP FOR GIRDERS | |
| 011/006133 | 065304 | EC2-4/12-14 CLIP | EDGE CLIP FOR GIRDERS | |
| 011/006134 | 065305 | EC2-4/15-19 CLIP | EDGE CLIP FOR GIRDERS | |
| 011/006135 | 065306 | EC2-4/20-24 CLIP | EDGE CLIP FOR GIRDERS | |
| 011/006136 | 065307 | EC2-4/25-32 CLIP | EDGE CLIP FOR GIRDERS | |
| 054/010251 | 065353 | EC8-12/15-19 CLIP | EDGE CLIP FOR GIRDERS | |
| 054/010249 | 065352 | EC8-12/12-14 CLIP | EDGE CLIP FOR GIRDERS | |
| | | | | |

For price and delivery contact sales.

TEL:- (01782) 575316 FAX:- (01782) 834201 E-MAIL:- rseltd@btconnect.com

R.S.ELECTRICAL (RSE) LTD.

SPECIALIST SUPPLIERS TO THE RAIL INDUSTRY.



SECTION 13
ACCOUNT APPLICATION
FORM AND
CONDITIONS OF SALE

For price and delivery contact sales.

TEL:- (01782) 575316 FAX:- (01782) 834201 E-MAIL:-rseltd@btconnect.com

[Return to top](#)

R.S.ELECTRICAL (RSE) LTD.

SPECIALIST SUPPLIERS TO THE RAIL INDUSTRY.



(Cancelling all previous Issues) Conditions of Sale

1. General

All tenders and quotations are made and contracts and orders are accepted upon and subject to the following conditions of sale which, shall operate to the exclusion of any other conditions and terms, put forward by the Buyer irrespective of the dates of despatch or receipt of any such conditions.

2. Prices

All prices published or quoted are subject to alteration without notice and, unless otherwise stated by us in writing, all orders are accepted on the condition that prices charged will be those current at the time of despatch. All prices are exclusive of VAT which will be charged at the appropriate rate.

3. Delivery

Whilst every endeavour will be made to maintain estimated delivery dates, we cannot accept any liability for losses of any kind arising from any delay in delivery or failure to deliver.

4. Carriage and Packing

We reserve the right to decide whichever is the most suitable method of despatch for the goods to the Buyer or his nominated delivery address, and to charge accordingly. Our table of charges is laid out at the front of this catalogue. No charge is made for standard non-returnable packing cases or cartons.

5. Returns

No returns can be accepted, for whatever reason, unless our consent has been obtained. Credit will be subject to costs arising from inspection of returned Goods. Returned Goods must be consigned carriage paid to RSE Ltd.

6. Designs and Descriptive Matter

We reserve the right to change the design of goods or parts thereof without notice. All illustrations, descriptions, and dimensions published in respect of Goods are typical only, and not binding.

7. Terms of Payment

We reserve the right to suspend deliveries to a customer whose account is overdue. Should the buyer go into receivership or liquidation, all sums due to us shall become due for payment.

8. Copyrights and Patents

All drawings, plans, sketches, specifications and other documents and materials relating to Goods produced by or for use are our property. All intellectual property rights in or relating to the Goods (including without limitation copyright and patents) belong to and are reserved by us and neither the Buyer nor any other person, firm or corporation shall have any right or licence to reproduce or use the same for the repair of the Goods for any other purpose whatsoever without our prior written consent. All information relating to the Goods (other than information in the public domain) is confidential and any disclosure to any third party requires our prior written consent.

9. Legal Construction

Any contract or sale shall in all respects be construed and operate as an English contract and in conformity with English Law and the parties agree to submit to the non-exclusive jurisdiction of English Courts.

For price and delivery contact sales.

TEL:- (01782) 575316 FAX:- (01782) 834201 E-MAIL:- rseltd@btconnect.com

R.S.ELECTRICAL (RSE) LTD.

SPECIALIST SUPPLIERS TO THE RAIL INDUSTRY.



10. Guarantee

Any conditions or warranties (whether express or implied by statute, common law or arising from conduct or a previous course of dealing or trade custom or usage) as to the quality or fitness of the Goods for any particular purpose, or that the Goods will correspond with any description or sample, are hereby void and excluded. In substitution for all rights which the Buyer would or might have had but for these conditions, we shall replace free of charge or repair at our option any Goods found to be faulty in material or workmanship providing that no attempt has been made to alter, dismantle or rectify in any way and providing the Goods have been used for the purpose for which they were designed. Before we become liable under this guarantee, if we require, the defective Goods or parts be delivered carriage paid to our Works at the Buyers risk. If we replace or repair, the returned Goods will be re-delivered carriage paid. In the case of Goods or parts not of our manufacture, these shall be subject to the terms of the makers guarantee. We shall not be liable for any costs claims, damages or expenses arising out of any breach of contract or statutory duty calculated by reference to profits, or loss of such profits, income, production or accruals or by reference to accrual of such costs, claims damages or expenses on a time basis. Nothing herein shall have the effect of excluding or restricting our liability for death or personal injury resulting from our negligence in so far as the same is prohibited by United Kingdom statute.

11. Passing of Title and Risk

From the time of delivery the Goods shall be the risk of the Buyer, who shall be solely responsible for their custody and maintenance as if he were the owner, but, unless otherwise expressly agreed in writing, the Goods shall remain our property until all payments due under the contract made between us and the Buyer have been made in full and unconditionally or until re-sale of the Goods by the Buyer bona fide in the ordinary course of this business and at full market price and the Buyer shall sell as principal only. While our ownership continues, the Buyer, as our bailee, shall keep our Goods separate and identifiable from all other Goods in his possession. If the Goods are not paid for in accordance with clause 7, we reserve the right to remove the Goods from the Buyers premises and re-sell the Goods. Should the Goods be resold by the Buyer then we reserve beneficial entitlement to the proceeds of sale until full payment for the Goods has been made.

12. Damage or Loss In Transit

We will accept no liability for damage to or loss of Goods in transit. We advise that carriers receipts should be signed after examination of goods. Claims in respect of carriers liability must be notified to the carrier and ourselves within fourteen days of advice note and Invoice date in the case of non or incomplete delivery. In the event of failure to give notice within the aforementioned period, the Goods will be deemed to be in all respects as Invoiced and we will not accept any responsibility for such claims.

13. Force Majeure

We shall not be liable for any delay or failure in performing any obligation through any circumstances beyond our control including, but not limited to strikes, Lockouts, war, fire breakdown of plant machinery, or unavailability of raw material from normal source of supply.

14. Special Orders

Products which are not normally stock lines and which have been procured or made specially for the purchaser are not cancellable, except and unless the full value of the purchase order has been paid by the purchaser

For price and delivery contact sales.

TEL:- (01782) 575316 FAX:- (01782) 834201 E-MAIL:- rseltd@btconnect.com

R.S.ELECTRICAL (RSE) LTD.

SPECIALIST SUPPLIERS TO THE RAIL INDUSTRY.



If you wish to Apply for an account with us please use or copy these pages, fill in the information, then post the finished form, to us at the address below ensuring all fields are filled in. Please note the signature must be hand written and the original posted to us.

APPLICATION FOR CREDIT FACILITIES.

Company Name :-

Address 1 :-

Address 2 :-

Address 3 :-

Address 4 :-

Postcode :- **Reg. No. :-**

Tel. No. :- **Fax. No. :-**

Invoice Address 1 :-

Address 2 :-

Address 3 :-

Address 4 :-

Postcode :-

Tel. No. :- **Fax. No. :-**

Person responsible for Bought Ledger :-

Period Trading :-

Credit Required :- £

Bankers Name :-

Address 1 :-

Address 2 :-

Address 3 :-

Address 4 :-

Postcode :-

Bank Acc'nt Name :-

Acc'nt No. :- **Sort Code :-**

Trade references (Two Required.)

Ref. 1 Name :-

Address 1 :-

Address 2 :-

Address 3 :-

Address 4 :-

Postcode :-

For price and delivery contact sales.

TEL:- (01782) 575316 FAX:- (01782) 834201 E-MAIL:- rseltd@btconnect.com

R.S.ELECTRICAL (RSE) LTD.

SPECIALIST SUPPLIERS TO THE RAIL INDUSTRY.



Ref. 2 Name :-
Address 1 :-
Address 2 :-
Address 3 :-
Address 4 :-
Postcode :-

By submitting this application you acknowledge and agree that you are aware that 'Title of Goods' only passes on payment in full, and in consideration of the granting of credit facilities, that you agree to make settlement of accounts no later than 30 days from the end of the month of invoice and to our terms and conditions.

Signed By :- **Date :-**

Position in Company :-

For price and delivery contact sales.

TEL:- (01782) 575316 FAX:- (01782) 834201 E-MAIL:- rseltd@btconnect.com