

Auxiliary Contact Blocks
Timers
Interlock Units
Surge Suppressors
Connection Pieces

Add-on Accessories

Contents

Accessories for A... Series Contactors and for Contactor Relays

Auxiliary Contact Blocks - Front Mounting	4/2
Auxiliary Contact Blocks - Side Mounting	4/4
TE5S Electronic Timer for Star-Delta Starters	4/6
TP... Pneumatic Timer Blocks	4/8
Mechanical Interlock Units - Mechanical and Electrical Interlock Units	4/10
WB75-A Mechanical Latching Unit	4/12
Surge Suppressors for Contactor Coils	4/14
CB5... Impulse Contact Blocks	4/16
BL5-L Lamp Holder Block - BL5-F Fuse Holder Block	4/16
BA5-50 Function Markers	4/17
BP16 Mounting Piece	4/17
RA5 Interface Relays	4/18
LT... Terminal Shrouds	4/20
LK... Terminals for Control Lead Connections	4/21
LZ... Connector Terminals	4/22
LD... Additional Terminal Blocks	4/23
LX... Terminal Extension Pieces - LW... Terminal Enlargement Pieces	4/24
LP..., LY..., LH..., LF..., LG... Terminal Connecting Strips	4/25
BEM..., BES... Connection Sets	4/26
BED... Connection Sets	4/27
BEA 16 ... BEA 110 Connecting Links	4/28
BEA... and BEF... Connection Bars	4/30
Adapter Plates and Mounting Plates	4/28, 4/31
Main Contact Sets - Arc Chutes	4/33
Contactor Coils	4/34
Electrical Durability of Auxiliary Contacts	4/35

Accessories for EK... Series Contactors

Auxiliary Contact Blocks	4/36
Mechanical Interlock Units - Mechanical and Electrical Interlock Units	4/38
Surge Suppressors for Contactor Coils	4/40
Terminal Shrouds	4/42
Connection Sets	4/42
Mounting Plates	4/43
Main Contact Sets - Arc Chutes - Contactor Coils	4/44
Electrical Durability of Auxiliary Contacts	4/45

Auxiliary Contact Blocks

Front Mounting



CA 5-10



CA 5-40 E



CE 5-01 W

Application

The auxiliary contact blocks are used for the operation of auxiliary circuits and control circuits.

Description

Types of auxiliary contact blocks for standard industrial environments:

- **CA...** 1 or 4-pole block, instantaneous with N.O., N.C. contacts.
- **CC...** 1-pole block, with N.O. leading contact or N.C. lagging contact.

Select the 4-pole auxiliary contact blocks **CA 5-..E**, **CA 5-..M**, **CA 5-..U** or **CA 5-..N** type, according to the contactor or contactor relay type for compliance with the standard requirements. (see "Terminal Marking and Positioning").

Types of auxiliary contact blocks for severe industrial environments:

- **CE...** 1-pole block, instantaneous with N.O. contact or N.C. contact, designed in 2 protection versions:
 - **CE 5-.. D** with built-in microswitch IP 40, degree of protection (IP 20 on terminals)
 - **CE 5-.. W** with built-in microswitch IP 67, degree of protection (IP 20 on terminals).

The auxiliary contact blocks are equipped with screw type connecting terminals delivered open, protected against accidental direct contact and bear the corresponding function marking.

Fitting Details - For each contactor or contactor relay type, refer to "Accessory Fitting Details" table.

Ordering Details

For contactors	Number of blocks (1)	Contact blocks 	Type	Order code	Pack ^{m9} pieces	Weight kg
						1 piece

1-pole auxiliary contact blocks

A 9 ... A 26	1-4	1 – – –	CA 5-10	1SBN 010 010 R1010	10	0.014
A 30, A 40	1-5	– 1 – –	CA 5-01	1SBN 010 010 R1001	10	0.014
A 45 ... A 110	1-6	– – 1 –	CC 5-10	1SBN 010 011 R1010	10	0.014
AL 9 ... AL 26	1-4	– – – 1	CC 5-01	1SBN 010 011 R1001	10	0.014
AL 9Z ... AL 16Z	1-2					
AL 30, AL 40	1-5	1 – – –	CE 5-10 D 0.1	1SBN 010 015 R1010	1	0.020
AE 45 ... AE 110	1-6	– 1 – –	CE 5-01 D 0.1	1SBN 010 015 R1001	1	0.020
TAL 9 ... TAL 26	1-4	1 – – –	CE 5-10 D 2	1SBN 010 017 R1010	1	0.020
TAL 30, TAL 40	1-5	– 1 – –	CE 5-01 D 2	1SBN 010 017 R1001	1	0.020
TAE 45 ... TAE 110	1-6	1 – – –	CE 5-10 W 0.1	1SBN 010 016 R1010	1	0.020
AF 45 ... AF 110	1-6	– 1 – –	CE 5-01 W 0.1	1SBN 010 016 R1001	1	0.020
N, NL and TNL (4-pole)	1-4	1 – – –	CE 5-10 W 2	1SBN 010 018 R1010	1	0.020
NL Z (4-pole)	1-2	– 1 – –	CE 5-01 W 2	1SBN 010 018 R1001	1	0.020

4-pole auxiliary contact blocks

A 9 ... A 26-40-00	1					
A 9 ... A 26-22-00	1					
A 45 ... A 110	1	4 – – –	CA 5-40 E	1SBN 010 040 R1040	2	0.060
AL 9 ... AL 26-40-00	1	3 1 – –	CA 5-31 E	1SBN 010 040 R1031	2	0.060
AL 9 ... AL 26-22-00	1	2 2 – –	CA 5-22 E	1SBN 010 040 R1022	2	0.060
AE 45 ... AE 110	1	0 4 – –	CA 5-04 E	1SBN 010 040 R1004	2	0.060
TAL 9 ... TAL 26-40-00	1	1 1 1 1	CA 5-11/11 E	1SBN 010 040 R1018	2	0.060
TAL 9 ... TAL 26-22-00	1					
TAE 45 ... TAE 110	1					
AF 45 ... AF 110	1					
A 9 ... A 40-30-10	1	3 1 – –	CA 5-31 M	1SBN 010 040 R1131	2	0.060
AL 9 ... AL 40-30-10	1	2 2 – –	CA 5-22 M	1SBN 010 040 R1122	2	0.060
TAL 9 ... TAL 40-30-10	1	1 3 – –	CA 5-13 M	1SBN 010 040 R1113	2	0.060
		0 4 – –	CA 5-04 M	1SBN 010 040 R1104	2	0.060
		1 1 1 1	CA 5-11/11 M	1SBN 010 040 R1118	2	0.060
A 9 ... A 40-30-01	1	4 – – –	CA 5-40 U	1SBN 010 040 R1340	2	0.060
AL 9 ... AL 40-30-01	1	3 1 – –	CA 5-31 U	1SBN 010 040 R1331	2	0.060
TAL 9 ... TAL 40-30-01	1	2 2 – –	CA 5-22 U	1SBN 010 040 R1322	2	0.060
		0 4 – –	CA 5-04 U	1SBN 010 040 R1304	2	0.060
N, NL and TNL (4-pole)	1	4 – – –	CA 5-40 N	1SBN 010 040 R1240	2	0.060
		3 1 – –	CA 5-31 N	1SBN 010 040 R1231	2	0.060
		2 2 – –	CA 5-22 N	1SBN 010 040 R1222	2	0.060
		1 3 – –	CA 5-13 N	1SBN 010 040 R1213	2	0.060
		0 4 – –	CA 5-04 N	1SBN 010 040 R1204	2	0.060

(1) For each contactor or contactor relay type, refer to "Accessory Fitting Details" table.

Note: The auxiliary contact blocks provided for the **A...** contactors can be used for the **UA...**, **GA...** and **GAE...** types.



>> **Accessory Fitting Details (Contactors)** section 2 >> **Side Mounted Auxiliary Contact Blocks** page 4/4
 >> **Accessory Fitting Details (Contactors Relays)** section 3 >> **Auxiliary Contacts for Safety Circuits** ... pages 2/63, 3/15

Auxiliary Contact Blocks

Front Mounting

Technical Data

Utilization characteristics according to IEC

Types	1-pole CA 5..., 4-pole CA 5..., 1-pole CC 5...	1-pole CE 5-..0.1	1-pole CE 5-..2
Compliance with standards	IEC 60947-5-1 and EN 60947-5-1		
Rated insulation voltage U_i acc. to IEC 60947-5-1 V	690	250	250
Rated operational voltage U_e V a.c.	24 ... 690	125	250
Conventional thermal current I_{th} A	16	0.1	2
Rated operational current I_e acc. to IEC 60947-5-1	AC-15	AC-14	AC-15
24 ... 127 V a.c. A	6	0.1	2
220 ... 240 V a.c. A	4	–	2
380 ... 440 V a.c. A	3	–	–
500 ... 690 V a.c. A	2	–	–
Rated operational current I_e acc. to IEC 60947-5-1	DC-13	DC-12	DC-12
24 V d.c. A	6 (144 W)	0.1	2
48 V d.c. A	2.8 (134 W)	0.1	1
72 V d.c. A	1 (72 W)	0.1	0.3
110 V d.c. A	0.55 (60 W)	0.1	0.2
125 V d.c. A	0.55 (69 W)	–	0.2
220 V d.c. A	0.3 (66 W)	–	0.1
250 V d.c. A	0.3 (75 W)	–	–
Short circuit protection A	10 (gG fuses)	0.1 (FF fuses*)	10 (FF fuses*)
Making capacity	10 x I_e AC-15	6 x I_e AC-14	10 x I_e AC-15
Breaking capacity	10 x I_e AC-15	6 x I_e AC-14	10 x I_e AC-15
Rated short-time withstand current I_{cw} 1 s A	100	–	–
$\theta = 40^\circ\text{C}$ 0.1 s A	140	–	–
Power loss per pole at 6 A W	0.10	–	–
Min. switching capacity			
– A 9 ... A 75 contactors V / mA	17 / 1	3 / 1	17 / 1
with failure rate acc. to IEC 60947-5-4	$\leq 10^{-7}$	–	$\leq 10^{-7}$
– A 95, A 110 contactors V / mA	24 / 50	3 / 1	17 / 1
with failure rate acc. to IEC 60947-5-4	–	–	$\leq 10^{-7}$
Mechanical durability			
– millions of operating cycles	10 (A 9 ... A 75) 3 (A 95, A 110)	5 for CE 5-.. D 0.1 2.5 for CE 5-.. W 0.1	5 for CE 5-.. D 2 2.5 for CE 5-.. W 2
– max. mech. switching frequency cycles/h	3600	3600	3600
Electrical durability			
– millions of operating cycles	see "Electrical Durability" curves	2.5 for CE 5-.. D 0.1 0.7 for CE 5-.. W 0.1	1 for CE 5-.. D 2 0.3 for CE 5-.. W 2
– max. elec. switching frequency cycles/h	1200	1200	1200
Connecting terminals (Delivered in open position. Screws of unused terminals should be tightened.)	M3.5 (+,-) pozidriv 2 screws with cable clamp		
Tightening torque			
– recommended Nm	1.00		
– max. Nm	1.20		
Connecting capacity (min. ... max.)			
Rigid solid  1 or 2 x mm ²	1 ... 4		
Flexible with cable end  1 or 2 x mm ²	0.75 ... 2.5		
Lugs  L mm \leq l mm $>$	7.7 3.7		
Degree of protection acc. to IEC 60947-1 / EN 60947-1 and IEC 60529 / EN 60529	IP 20	IP 40 for CE 5-.. D 0.1 IP 67 for CE 5-.. W 0.1	IP 40 for CE 5-.. D 2 IP 67 for CE 5-.. W 2
Terminals Microswitches	–		
	–		
		* HRC fuses for very fast action (6.3 x 32 mm size)	
Utilization characteristics according to UL/CSA			
Max. rated voltage V	600	125	250
Pilot duty	A600, Q300	0.1 A	2.0 A

>> Accessory Fitting Details sections 2, 3 >> Auxiliary Contacts for Safety Circuits pages 2/63, 3/15 >> Certification and Approvals section 7	>> Side Mounted Auxiliary Contact Blocks page 4/4 >> Electrical Durability Curves page 4/35 >> Terminal Marking and Positioning section 8 >> Dimensions section 9
--	--

Auxiliary Contact Blocks

Side Mounting



CAL 5-11

1SBK5 7376 2F0301



CAL 18-11

1SFC1 0103 3F0201

Application

The auxiliary contact blocks are used for the operation of auxiliary circuits and control circuits.

Description

Types of auxiliary contact blocks for standard industrial environments:

- **CAL...** 2-pole block instantaneous N.O. + N.C. contacts.
- **CCL 5-11** 2-pole block N.O. leading + N.C. lagging contacts.

Type of auxiliary contact block for severe industrial environments:

- **CEL 18-...** 1-pole block with built-in microswitch IP 67 degree of protection (IP 20 on terminals). Instantaneous N.O. or N.C. contact.

The auxiliary contact blocks are equipped with screw type connecting terminals delivered open, protected against accidental direct contact, and bear the corresponding function marking.

Fitting Details

Clipped onto the right and/or lefthand side of the contactors.

The **CAL 18-11B** is a second block for mounting in addition to a first **CAL 18-11** block, right and/or lefthand of the A 145 ... A 300 and AF 145 ... AF 1650 contactors.

For each contactor or contactor relay type, refer to "Accessory Fitting Details" table.

Ordering Details

For contactors	Number of blocks	Contact blocks	Type	Order code	Pack ^{ing} pieces	Weight kg
	(1)					1 piece

2-pole auxiliary contacts N.O. + N.C.

A 9 ... A 75	1-2		CAL 5-11	1SBN 010 020 R1011	2	0.050
AL 9 ... AL 40	1					
AE 45 ... AE 75	1					
TAL 9 ... TAL 40	1					
TAE 45 ... TAE 75	1					
AF 45 ... AF 75	1-2					
UA 16 ... UA 75	1-2		CAL 18-11	1SFN 010 720 R1011	2	0.050
N	1-2					
NL (4-pole)	1					
A 95 ... A 300	1-2					
AE 95, AE 110	1					
TAE 95, TAE 110	1					
AF 95 ... AF 1650	1-2		CAL 18-11B	1SFN 010 720 R3311	2	0.050
UA 95, UA 110	1-2					
A 145 ... A 300	1-2 ⁽²⁾		CAL 18-11B	1SFN 010 720 R3311	2	0.050
AF 145 ... AF 1650	1-2 ⁽²⁾					

2-pole auxiliary contacts N.O. leading + N.C. lagging

A 9 ... A 16	1-2		CCL 5-11	1SBN 011 421 R1008	2	0.050
N	1-2					

1-pole microswitch auxiliary contact N.O. or N.C.

A 95 ... A 300	1-2		CEL 18-10	1SFN 010 716 R1010	1	0.050
AF 95 ... AF 1650	1-2					
UA 95, UA 110	1-2					
A 95 ... A 300	1-2		CEL 18-01	1SFN 010 716 R1001	1	0.050
AF 95 ... AF 1650	1-2					
UA 95, UA 110	1-2					

(1) For each contactor or contactor relay type, refer to "Accessory Fitting Details" table

(2) 2 blocks **CAL 18-11** + 2 blocks **CAL 18-11 B**

Note: The **CAL...** auxiliary contact blocks can be used for **UA..RA** contactors. See "Accessory Fitting Details" for this contactor type.

The **CAL...** auxiliary contact blocks can be used for **GA...** contactors:

- GA 75-10-00 : 2 x CAL 5-11 blocks
- GA 75-10-11 : 1 x CAL 5-11 block
- GAE 75-10-00 : 1 x CAL 5-11 block
- GAE 75-10-11 : no add-on block

>> Accessory Fitting Details for Contactors section 2
>> Accessory Fitting Details for Contactor Relays section 3



>> Front Mounted Aux. Contact Blocks page 4/2
>> Aux. Contacts for Safety Circuits pages 2/63, 3/15

Auxiliary Contact Blocks

Side Mounting

Technical Data

Utilization characteristics according to IEC

Types	CAL 5-11, CCL 5-11	CAL 18-11, CAL 18-11B	CEL 18-10, CEL 18-01
Compliance with standards	IEC 60947-5-1, EN 60947-5-1		
Rated insulation voltage U_i according to IEC 60947-5-1	V 690		250
Rated operational voltage U_e	V a.c. 24 ... 690		125
Conventional free air thermal current I_{th}	A 16		0.1
Rated operational current I_e acc. to IEC 60947-5-1	AC-15		AC-14
24-127 V a.c.	A 6		0.1
220-240 V a.c.	A 4		–
380-440 V a.c.	A 3		–
500-690 V a.c.	A 2		–
acc. to IEC 60947-5-1	DC-13		DC-12
24 V d.c.	A 6 (144 W)		0.1
48 V d.c.	A 2.8 (134 W)		0.1
72 V d.c.	A 1 (72 W)		0.1
110 V d.c.	A 0.55 (60 W)		0.1
125 V d.c.	A 0.55 (69 W)		–
220 V d.c.	A 0.3 (66 W)		–
250 V d.c.	A 0.3 (75 W)		–
Short-circuit protection	A 10 (gG type fuses)		0.1 (FF type fuses) (1)
Making capacity	10 x I_e AC-15		6 x I_e AC-14
Breaking capacity	10 x I_e AC-15		6 x I_e AC-14
Rated short-time withstand current I_{cw} 1 s	A 100		–
$\theta = 40^\circ\text{C}$ 0.1 s	A 140		–
Power loss per pole at 6 A	W 0.10	0.15	–
Min. switching capacity	V / mA 17 / 1	24 / 50 (0.5 million of operating cycles)	3 / 1
with failure rate acc. to IEC 60947-5-4	$\leq 10^{-7}$	–	–
Mechanical durability – millions of operating cycles	10	5 (A/AF 95 ... A/AF 185) 3 (A/AF 210 ... AF 750) 0.5 (AF 1350, AF 1650)	1
– max. mech. switching frequency	cycles / h 3600		1200
Electrical durability – millions of operating cycles	see "Electrical Durability" curves		0.7
– max. elec. switching frequency	cycles / h 1200		1200
Connecting terminals (Delivered in open position. Screws of unused terminals should be tightened.)	M3.5 (+,-) pozidriv 2 screws with cable clamp		
Tightening torque – recommended	Nm 1.00		
– max.	Nm 1.20		
Connecting capacity (min. ... max.)			
Rigid solid  1 or 2 x mm ²	1 ... 4		
Flexible with cable end  1 or 2 x mm ²	0.75 ... 2.5		
Lugs  L mm ≤ l mm >	8 3.7		
Degree of protection according to IEC 60947-1 / EN 60947-1 and IEC 60529 / EN 60529	IP 20		

Utilization characteristics according to UL/CSA

Max. rated voltage	V 600	125
Pilot duty	A600, Q300	0.1 A

(1) HRC fuses for very fast action (size 6.3 x 32 mm).

>> Electrical Durability Curves page 4/35	>> Terminal Marking and Positioning section 8
>> Certification and Approvals section 7	>> Dimensions section 9

TE5S Electronic Timer for Star-Delta Starters



TE5S...

Application

When used in star-delta starters, the **TE5S** lags the star connection and provides a lapse of 50 ms before the switch over to delta connection.

Description

According to the type of device chosen, the electronic circuit has a 24 V a.c./d.c., 110 to 120 V a.c., 220 to 240 V a.c. or 380 to 440 V a.c. supply. An output relay with reversing contact ensures high current switching. A two-position switch allows selection of one of the two time delay ranges: 0.8 to 8 s or 6 to 60 s. The 0.1 to 1.0 graduated button allows an initial setting without steps within the previously selected range which can then be adjusted using a chronometer.

Note: We recommend that you allow for temperature drift for the final adjustment of the time delay setting. Drift: -0.2 % per °C.

For example, a setting made at 20 °C will yield a time delay shorter by 7 % at 55 °C in a cubicle. (-0.2 % per °C i.e. $-0.2 \times 35 = -7\%$).

Regardless of these settings the **TE5S** provides a fixed "lapse" of 50 ms between the opening of contact 15-16 and the closing of contact 15-18. This time delay prevents from arc short-circuit during star to delta switching.

Operation

On energization, the green U indicator light (voltage applied) comes on. Contact 15-16 then immediately moves to the closed position.

Count-down of the programmed time immediately commences.

When the time delay has elapsed, contact 15-16 opens and at the same time the 50 ms lapse, t_2 , begins after which contact 15-18 moves to the closed position. The yellow R indicator light comes on.

On de-energization, the U and R indicator lights go out and, after the 250 ms resetting time, the device is ready for a new cycle.

Mounting

On 35 x 7.5 mm or 35 x 15 mm mounting rail according to IEC/EN 60715.

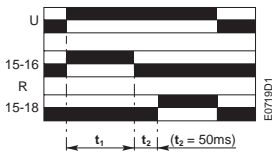

Chart

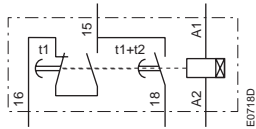

Equivalent diagram

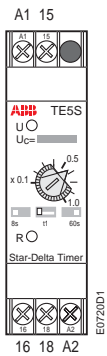

Front face

Ordering Details

For contactors	Rated control voltage U_c V	Type	Order code	Pack ^{ing} pieces	Weight kg
A 9 ... A 300	24 a.c./d.c.	TE5S-24	1SBN 020 010 R1001	1	0.080
	110 ... 120 a.c.	TE5S-120	1SBN 020 010 R1002	1	0.080
	220 ... 240 a.c.	TE5S-240	1SBN 020 010 R1003	1	0.080
	380 ... 440 a.c	TE5S-440	1SBN 020 010 R1004	1	0.080

Dimensions (in mm)

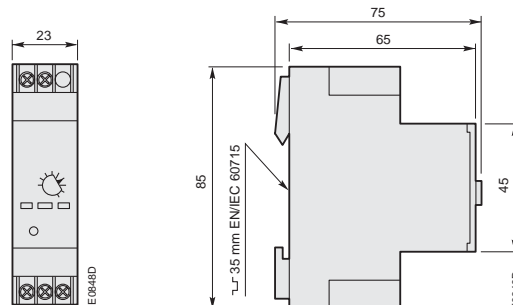

TE5S Electronic Timer for Star-Delta Starters

Technical Data

Types	TE5S-24	TE5S-120	TE5S-240	TE5S-440
Compliance with standards	IEC 60947-5-1, EN 60947-5-1			
Rated insulation voltage U_i according to IEC 60947-5-1	V 440			
Rated operational voltage U_e according to IEC 60947-5-1	V d.c. 24 V a.c. 24 ... 240			– 440
Conventional free air thermal current I_{th}	A 10			
Rated operational current I_e acc. to IEC 60947-5-1				
AC-15 24-120 V a.c.	A 5			–
220-240 V a.c.	A 4			–
380-440 V a.c.	A –			3
DC-13 24 V d.c.	A 4			–
Short-circuit protection - gG type fuses	A 10			
Rated supply voltage U_c	V d.c. 24 V a.c. 24	– 110 ... 120	– 220 ... 240	– 380 ... 440
– Rated frequency limits	Hz 48 ... 63			
– Supply voltage range	0.85 ... 1.1 U_e			
– Overvoltage protection	Built-in varistor			
– Load factor	%			
– Average consumption	– in d.c. W – in a.c. VA	– 3.5	– 6.5	– 12.5
Time delay range (t_d) selected by switch	s 0.8 ... 8 and 6 ... 60			
– Temperature drift	% per °C -0.2			
– Mechanical setting accuracy	±15 % of the setting range			
– On-load reiteration accuracy under constant conditions	±2 % after 1 million operating cycles			
Minimum time lapse (t_2)	ms 50			
Min. time lapse after 1 million operating cycles	ms 40			
Resetting time (maximum)	ms 250			
Front panel display: – green indicator light – yellow indicator light	Energization Output relay activated			
Permissible air temperature	°C			
– for operation	°C -25 ... +60			
– for storage	°C -40 ... +85			
Vibration withstand acc. to IEC 60068-2-6, EN 60068-2-6	3 g from 10 to 300 Hz in the 3 directions			
Shock withstand acc. to IEC 60068-2-27, EN 60068-2-27	20 g / 11 ms in directions A and C 15 g / 11 ms in direction B			
Electrical durability in millions of op. cycles	1			
Mechanical durability in millions of op. cycles	5			
On-load maximum switching frequency	cycles/h 720			600
Fixing on mounting rail acc. to IEC/EN 60715	35 x 7.5 or 35 x 15			
Connecting terminals	(+, -) pozidriv 1 screw			
Connecting capacity				
– rigid solid	1 or 2 x mm ²			
– flexible with cable end	1 or 2 x mm ²			
Tightening torque	Nm 0.6 ... 0.8 max.			
Degree of protection according to IEC 60947-1 / EN 60947-1 and IEC 60529 / EN 60529	Terminals IP 20			

4

TP... Pneumatic Timer Blocks



TP 40 DA

1SBC5 7589 3 F0302



BX-TP

1SBC5 8652 2F0301

Application

The timer blocks are equipped with adjustable time delay auxiliary contacts.

Types

- TP 40 DA, TP 180 DA (blue button) for time delay on energization.
- TP 40 IA, TP 180 IA (black button) for time delay on de-energization.

Description

- Pneumatic timer with 350° linear scale and setting via marked knurled knob.
- Block equipped with 2 time-delayed auxiliary contacts: 1 N.O. and 1 N.C.
- Captive screw type connecting terminals with built-in cable clamps. M3.5 (+,-) pozidriv 2 screw with screwdriver guidance, supplied untightened and protected against accidental direct contact.

Accessory

BX-TP plastic sealed cover protecting access to the time delay setting.

Fitting Details

Clipped onto the front panel of **A 9 ... A 75** 1-stack contactors and **N...** 1-stack contactor relays.

For each contactor or contactor relay type, refer to "Accessory Fitting Details" table.

Ordering Details

Time delay setting	Type	Order code	Pack ^{ing} pieces	Weight kg
0.1 ... 40 s	TP 40 DA	1SBN 020 300 R1000	1	0.070
10 ... 180 s	TP 180 DA	1SBN 020 300 R1001	1	0.070
0.1 ... 40 s	TP 40 IA	1SBN 020 301 R1000	1	0.070
10 ... 180 s	TP 180 IA	1SBN 020 301 R1001	1	0.070
—	BX-TP	FPTN 472 657 R0001	1	0.006



Note: The TP... timers provided for A contactors can be used for the AF, AE, TAE, UA, GA and GAE contactors.

>> Accessory Fitting Details sections 2, 3

TP... Pneumatic Timer Blocks

Technical Data

Utilization characteristics according to IEC

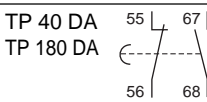
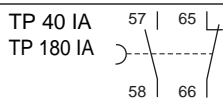
Compliance with standards	IEC 60947-5-1, EN 60947-5-1	
Rated insulation voltage U_i according to IEC 60947-5-1	V a.c.	690
Rated operational voltage U_e according to IEC 60947-5-1	V a.c.	24 ... 690
Conventional free air thermal current I_{th}	A	10
Rated operational current I_e acc. to IEC 60947-5-1		
AC-15	24-127 V a.c. A	6
	220-240 V a.c. A	4
	380-440 V a.c. A	3
	500 V a.c. A	1
	690 V a.c. A	0.5
DC-13	24 V d.c. A	6 (144 W)
	48 V d.c. A	2.8 (134 W)
	72 V d.c. A	1 (72 W)
	110 V d.c. A	0.55 (60 W)
	125 V d.c. A	0.55 (69 W)
	220 V d.c. A	0.3 (66 W)
	250 V d.c. A	0.3 (75 W)
Making capacity	10 x I_e AC-15	
Breaking capacity	10 x I_e AC-15	
Short-circuit protection - gG type fuses	A	10
Rated short-time withstand current I_{cw} at $\theta = 40^\circ\text{C}$		
	1 s A	50
	0.1 s A	100
Heat loss per pole at 6 A	W	0.15
N.O. and N.C. contact non-overlapping time	ms	1 ... 2
Resetting time	ms	approx. 40
Accuracy (measured over 10 successive cycles)	$\pm 2\%$	
Drift (variation in mean value during TP lifetime)	TP ... DA: -15 to +15 %	TP ... IA: -25 to +15 %
Drift according to ambient temperature		
- between -20 °C and +20 °C	% per °C	0.25
- between +20 °C and +65 °C	% per °C	0.20
Electrical durability	see "Electrical Durability" curves	
Max. switching frequency	cycles/h	1200
Mechanical durability	cycles	5 millions
Connecting terminals (delivered in open position)	M3.5 (+,-) pozidriv 2 screws with cable clamp	
Connecting capacity		
- rigid solid	 1 or 2 x mm²	1 ... 2.5
- flexible with cable end	 1 or 2 x mm²	0.75 ... 2.5
Tightening torque		
- recommended	Nm	1.00
- max.	Nm	1.20
Terminal marking	 TP 40 DA 55 67 TP 180 DA 56 68	 TP 40 IA 57 65 TP 180 IA 58 66

Utilization characteristics according to UL/CSA

Max. rated voltage	V	600
Pilot duty		A600

Mechanical Interlock Units

Mechanical and Electrical Interlock Units



VM 300H

1SBC5 8041 1F0001

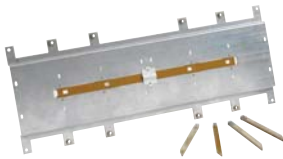

VM 1650H

1SFC1 0102 4R0201

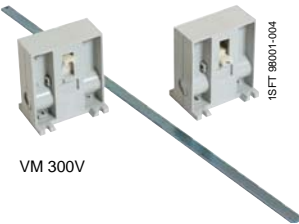

VM 300V

1SFT 98001-004



VE 5-1

1SBC5 7282 2F0301

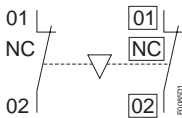

VE 5-1, VE 5-2
Terminal marking and positioning

Application

When mounted between two contactors, the mechanical interlock unit prevents one of the contactors from closing as long as the other contactor is closed.

Description

- **VM...** interlock units for mechanical interlocking of two horizontal or vertical mounted a.c. or d.c. operated contactors.
- **VE...** interlock units for mechanical and electrical interlocking of two horizontal mounted a.c. or d.c. operated contactors.

See selection tables on the opposite page showing interlocking details between two contactors of a same or different rating.

Ordering Details

For contactors	Type	Order code	Pack ^{ing} pieces	Weight kg
Mechanical interlock units for two horizontal mounted contactors (1)				
see opposite "Selection Table"	VM 5-1	1SBN 030 100 R1000	1	0.066
	VM 300H	1SFN 034 700 R1000	1	0.150
	VM 300/460H	1SFN 035 100 R1000	1	0.150
	VM 750H	1SFN 035 700 R1000	1	0.200
	VM 1650H	1SFN 036 503 R1000	1	6.000

(1) Mechanical durability: VM 5-1 = 5 millions cycles, VM 300H ... VM 750H = 1 million cycles.

Mechanical interlock units for two vertical mounted contactors (1)

see opposite "Selection Table"	VM 300V	1SFN 034 701 R1000	1	0.150
	VM 300/460V	1SFN 035 101 R1000	1	0.150
	VM 750V	1SFN 035 701 R1000	1	0.200

(1) Mechanical durability: VM 300V ... VM 750V = 1 million cycles.

Mechanical and electrical interlock units for two horizontal mounted contactors

see opposite "Selection Table"	VE 5-1	1SBN 030 110 R1000	1	0.076
	VE 5-2	1SBN 030 210 R1000	1	0.146

Technical Data - VE 5-1 and VE 5-2 Mechanical and Electrical Interlock Units

Compliance with standards	IEC 60947-5-1, EN 60947-5-1		Rated short-time withstand current I_{cw} - $\theta = 40^\circ\text{C}$		
Rated insulation voltage U_i according to IEC 60947-5-1	V	690	1 s	A	100
according to UL / CSA	V	600	0.1 s	A	140
Rated operational voltage U_e acc. to IEC 60947-5-1	V a.c.	24 ... 690	Short-circuit protection gG type fuses	A	10
Conventional thermal current I_{th}	A	16	Heat loss per pole at 6 A	W	0.15
Rated operational current I_e acc. to IEC 60947-5-1			Mechanical durability	cycles	5 millions
AC-15			Max. switching frequency	cycles/h	600
24-127 V	A	6	Connecting capacity		
220-240 V	A	4	- rigid solid	1 or 2 x mm²	1 ... 4
380-440 V	A	3	- flexible with cable end	1 or 2 x mm²	0.75 ... 2.5
500-690 V	A	2	Connecting terminals delivered in open position (screws of unused terminals should be tightened)		M3.5 (+,-) pozidriv 2 screws with cable clamp
DC-13			Tightening torque		
24 V	A	6	- recommended	Nm	1.00
48 V	A	2.8	- max.	Nm	1.20
72 V	A	1	Degree of protection acc. to IEC 60947-1 / EN 60947-1 and IEC 60529 / EN 60529		IP 20
125 V	A	0.55			
250 V	A	0.3			
Making capacity		$10 \times I_e$ AC-15			
Breaking capacity		$10 \times I_e$ AC-15			

Technical note: When, during switching, the arc time is estimated to more than 40 ms, the closing signal of one of the two contactors must be delayed with respect to the opening signal of the other contactor in order to prevent a short-circuit.

Use a **TP 40** pneumatic timer or a **TE5S** electronic timer with time lapse, as applicable.

>> Accessory Fitting Details sections 2, 3
>> Mounting Plates page 4/31

>> Dimensions section 9

Mechanical Interlock Units

Mechanical and Electrical Interlock Units

Selection Tables - VM... Interlock Units

Mechanical interlocking of two a.c. or d.c. operated contactors

Horizontal mounting

Contactor types		AL 9 ... AL 16	AL 26 ... AL 40	A 9 ... A 40	A 45 ... A 110	A 145 ... A 300	AF 400, AF 460	AF 580, AF 750	AF 1350, AF 1650
Right	Left								
Left	Right								
AL 9 ... AL 16	VM 5-1	–	–	–	–	–	–	–	–
AL 26 ... AL 40	–	VM 5-1	–	–	–	–	–	–	–
A 9 ... A 40	–	–	VM 5-1	–	–	–	–	–	–
A 45 ... A 75	–	–	–	See table below (with VE 5-.. types)	–	–	–	–	–
A 95 ... A 185	–	–	–	–	VM 300H	–	–	–	–
A 210 ... A 300	–	–	–	–	VM 300H	VM 300/460H	–	–	–
AF 400 ... AF 750	–	–	–	–	–	VM 750H	VM 750H	–	–
AF 1350, AF 1650	–	–	–	–	–	–	–	–	VM 1650H
Fixing	Rail or PM 26-23 mounting plate (1) (to be supplied separately)				PN... mounting plate (to be supplied separately)			Mounting plate included	

(1) Rail mounting for: 2 x A 9 ... A 40 or 2 x AL 9 ... AL 40 contactors only.

2 x A 30, A 40 or 2 x AL 30, AL 40 contactors + MMS.

PM 26-23 mounting plate for: 2 x A 9 ... A 26 contactors + MMS, or 2 x AL 9 ... AL 26 contactors + MMS.

The interlock units provided for A... contactors can be used for AF types.

The interlock units provided for AL... contactors can be used for AL..Z, and TAL types, according to the "Fitting Details" table.

Vertical mounting

Contactor types		A 145 ... A 300	AF 400, AF 460	AF 580, AF 750
Down	Up			
Up	Down			
A 95 ... A 185	VM 300V	–	–	–
A 210 ... A 300	VM 300V	VM 300/460V	–	–
AF 400 ... AF 750	–	VM 750V	VM 750V	–
Fixing	Additional plate (not supplied)			

Selection Table - VE... Interlock Units

Mechanical and electrical interlocking of two a.c. or d.c. operated contactors

Horizontal mounting

Contactor types		AL 9 ... AL 16	AL 26 ... AL 40	A 9 ... A 26	A 30, A 40	A 45 ... A 75	A 95, A 110
Right	Left						
Left	Right						
AL 9 ... AL 16	VE 5-1	–	–	–	–	–	–
AL 26 ... AL 40	–	VE 5-1	–	–	–	–	–
A 9 ... A 26	–	–	VE 5-1	VE 5-1	–	–	–
A 30, A 40	–	–	VE 5-1	VE 5-1	VE 5-2	–	–
A 45 ... A 75	–	–	–	VE 5-2	VE 5-2	VE 5-2 (3)	–
A 95, A 110	–	–	–	–	VE 5-2 (3)	VE 5-2	–
Fixing	Rail or PM 26-23 mounting plate (1) (to be supplied separately)					Rail (2)	PN... mounting plate (to be supplied separately)

(1) Rail mounting for: 2 x A 9 ... A 40 or 2 x AL 9 ... AL 40 contactors only.

2 x A 30, A 40 or 2 x AL 30, AL 40 contactors + MMS.

PM 26-23 mounting plate for: 2 x A 9 ... A 26 contactors + MMS, or 2 x AL 9 ... AL 26 contactors + MMS.

(2) 2 contactors with or without MMS.

(3) The combination of A 45 ... 75 contactors interlocked with A 95, A 110 contactors cannot be mounted on symmetrical rail (75 mm, IEC/EN 60715).

The interlock units provided for A... contactors can be used for AE, TAE, AF, GA and GAE types.

The interlock units provided for AL... contactors can be used for TAL types, according to the "Fitting Details" table.

>> Accessories Fitting Details sections 2, 3	>> PM 26 Mounting Plate page 4/28
>> Dimensions section 9	>> PN... Mounting Plates page 4/31

WB 75-A Mechanical Latching Unit



WB 75-A

1SBC2 6548 3F0301

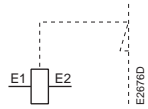

Terminal marking

Application

For converting standard contactors into latched contactors.

Description

The **WB 75-A** block contains a mechanical latching device with electromagnetic impulse unlatching (a.c. or d.c.) or manual unlatching.

Captive screw type connecting terminals, built-in cable clamps, M3.5 (+,-) pozidriv 2 screw with screwdriver guidance; delivered untightened and protected against accidental direct contact.

Operation

After closing, the contactor continues to be held in the closed position by the latching mechanism should the supply voltage fail at the contactor coil terminals.

Contactor opening can be controlled:

– electrically by an impulse* (a.c. or d.c.) on the WB 75-A block coil.

* the coil is not designed to be permanently energized.

– manually by pressing the pushbutton on the front face of the WB 75-A block.

Mounting

The **WB 75-A** block is clipped onto the front face of the 1-stack contactor where it takes up two slots. The two other slots may accept **CA 5...** single pole auxiliary contacts (1 block on each side of the mechanical latch).

Ordering Details

For contactors or contactor relays	Type	Order code	Weight kg Pack ^{ing} 1 piece
	state coil voltage <input type="text"/> (see table below)	state coil voltage code <input type="checkbox"/> <input type="checkbox"/> (see table below)	
A 9 ... A 75, AF 45 ... AF 75, AL 9 ... AL 40, AL 9Z ... AL 16Z, AE 45 ... AE 75, TAL 9 ... TAL 40, TAE 45 ... TAE 75, UA 16 ... UA 75, GA 75, GAE 75, N, NL, NL Z, TNL	WB 75-A <input type="text"/>	FPTN 372 726 R10 <input type="checkbox"/> <input type="checkbox"/>	0.120



Coil voltages and codes

Voltage <input type="text"/> V - 50Hz/d.c.	Voltage <input type="text"/> V - 60Hz	Code <input type="checkbox"/> <input type="checkbox"/>
24	24 ... 28	0 1
42	42 ... 48	0 2
48	48 ... 55	0 3
110	110 ... 127	0 4
220 ... 230	220 ... 255	0 6
230 ... 240	230 ... 277	0 5
380 ... 415	380 ... 440	0 7
415 ... 440	440 ... 480	0 8

>> Dimensions section 9

WB 75-A Mechanical Latching Unit

Technical Data

Rated insulation voltage U_i according to IEC 60947-1	V a.c.	690
Rated control voltage U_c according to the coil voltage	V a.c. V d.c.	24 ... 480 24 ... 440
Coil operating range		0.85 ... 1.1 U_c
Max. electrical impulse time – on a.c. coil (with load factor 5 %) – on d.c. coil (with load factor 3 %)	s s	20 8
Min. electrical impulse time – for latching: (energizing of the contactor coil)	in a.c. in d.c.	ms ms
		50 (A..., UA..., GA... contactors, N... contactor relays) 120 (AL..., AL.Z..., TAL... contactors and NL... NL.Z... TNL... contactor relays)
		120 (AF... contactors) 120 (AF... contactors)
		50 (AE..., TAE... contactors and GAE... contactors)
– for pull-out: (energizing of the WB block coil)	in a.c. in d.c.	ms ms
		30 50
Coil consumption (mean values) – a.c. operated coil	inrush holding	VA VA
		90 60
– d.c. operated coil	W	110
Operating time – on contactor closing (latching) between coil energization and: N.O. contact closing N.C. contact opening		
		no difference with the operation of a contactor without mechanical latching unit
– on contactor opening (unlatching) between WB.. coil energization and: N.O. contact opening N.C. contact closing	ms ms	5 ... 25 7 ... 28
Mechanical durability in millions of op. cycles		1
Max. switching frequency	cycles/h	3600 with on-load factor of 8 %
Connecting terminals (delivered in open position)		M3.5 (+,-) pozidriv 2 screw with cable clamp
Connecting capacity – rigid solid – flexible with cable end	 mm²  mm²	1 ... 4 0.75 ... 2.5
Tightening torque – recommended – max.	Nm Nm	1.00 1.20
Degree of protection acc. to IEC 60947-1 / EN 60947-1 and IEC 60529 / EN 60529		IP 20

Surge Suppressors for Contactor Coils

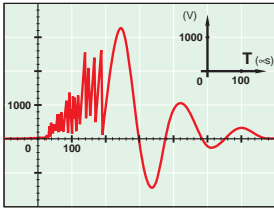

Application

The operation of inductive circuits causes overvoltages, in particular on opening of the contactor coil.

The electromagnetic energy stored in the coil during contactor closing is restored on opening in the form of surges, the slope and amplitude of which may rise to several kilovolts. A number of drawbacks are observed ranging from interference on the electronic devices to breakdown of insulators and even destruction of certain sensitive components.

The graph opposite reproduces the oscillogram showing voltage discharges at the terminals of a 42 V / 50 Hz coil without peak clipping. The coil was switched by 8 series-connected poles of a contactor relay.

Following a burst of discharges with a very steep slope a damped oscillation emerges with a peak value of 3500 V.

Overvoltage Factor

The overvoltage factor k is defined as the ratio of the maximum overvoltage peak value \hat{U}_s to the peak value \hat{U}_c of the coil rated control voltage U_c :

$$k = \frac{\hat{U}_s \text{ max.}}{\hat{U}_c} \quad \text{in d.c.: } k = \frac{\hat{U}_s \text{ max.}}{U_c} \quad \text{or in a.c.: } k = \frac{\hat{U}_s \text{ max.}}{U_c \sqrt{2}}$$

For example the following is obtained for the above graph: $k = \frac{3500}{42 \sqrt{2}} \approx 60$

Description

To reduce the harmful effects of these overvoltages, ABB has developed a range of surge suppressors designed to reduce the k factor defined above and to limit or even completely eliminate the high pre-damping voltage frequencies.

Each case is different, but the technical data tolerances and the generous sizing of parts have enabled us to reduce the number of variants.

We have chosen the following solutions: transil diodes, varistors and RC blocks.

Note: A varistor is a resistor whose value decreases to a very large extent when a certain voltage is applied at its terminals.

Ordering Details

For contactors	Control voltage		Type	Order code	Pack ^{ing} Weight	
	V	d.c. a.c.			pieces	kg
					1 piece	
AL 9 ... AL 40, AL 9Z ... AL 16Z, AE 45 ... AE 110, TAL 9 ... TAL 40, TAE 45 ... TAE 110 NL, NL Z, TNL	12 ... 32	● –	RT 5/32	1SBN 050 020 R1000	2	0.015
	25 ... 65	● –	RT 5/65	1SBN 050 020 R1001	2	0.015
	50 ... 90	● –	RT 5/90	1SBN 050 020 R1002	2	0.015
	77 ... 150	● –	RT 5/150	1SBN 050 020 R1003	2	0.015
	150 ... 264	● –	RT 5/264	1SBN 050 020 R1004	2	0.015
A 9 ... A 110 AL 9 ... AL 40, AL 9Z ... AL 16Z, AE 45 ... AE 110, TAL 9 ... TAL 40 TAE 45 ... TAE 110 N, NL, NL Z, TNL	24 ... 50	● ●	RV 5/50	1SBN 050 010 R1000	2	0.015
	50 ... 133	● ●	RV 5/133	1SBN 050 010 R1001	2	0.015
	110 ... 250	● ●	RV 5/250	1SBN 050 010 R1002	2	0.015
	250 ... 440	● ●	RV 5/440	1SBN 050 010 R1003	2	0.015
A 9 ... A 40 and N	24 ... 50	– ●	RC 5-1/50	1SBN 050 100 R1000	2	0.012
	50 ... 133	– ●	RC 5-1/133	1SBN 050 100 R1001	2	0.012
	110 ... 250	– ●	RC 5-1/250	1SBN 050 100 R1002	2	0.012
	250 ... 440	– ●	RC 5-1/440	1SBN 050 100 R1003	2	0.012
A 45 ... A 110	24 ... 50	– ●	RC 5-2/50	1SBN 050 200 R1000	2	0.015
	50 ... 133	– ●	RC 5-2/133	1SBN 050 200 R1001	2	0.015
	110 ... 250	– ●	RC 5-2/250	1SBN 050 200 R1002	2	0.015
	250 ... 440	– ●	RC 5-2/440	1SBN 050 200 R1003	2	0.015

Note: The surge suppressors provided for A... contactors can be used for the UA, UA..RA and GA 75 types.
The surge suppressors provided for AE 45 ... AE 110 contactors can be used for the GAE 75 types.

>> Technical Data page 4/15



RV 5/50



RC 5-1/50

Surge Suppressors for Contactor Coils

Technical Data

Transil diode		RT 5/32	RT 5/65	RT 5/90	RT 5/150	RT 5/264
Control voltage U_c	V d.c.	12 ... 32	25 ... 65	50 ... 90	77 ... 150	150 ... 264
Residual overvoltage (clipping voltage)	V d.c.	50	100	150	210	390
Opening time growth factor		1.5 ... 3				
Operating temperature	°C	-20 ... +70				
Connection to the coil terminals (parallel mounting)		Clip-on for both fixing and connection.				
Fixing		Clipped onto the top part of the contactor base without change in contactor overall dimensions.				
Advantages		Good energy absorption - Unpolarized system - Simple, reliable system.				
Drawback		A certain delay on drop out which does not however reduce contactor breaking capacity.				

Varistor		RV 5/50	RV 5/133	RV 5/250	RV 5/440
Control voltage U_c	V a.c./d.c.	24 ... 50	50 ... 133	110 ... 250	250 ... 440
Residual overvoltage (clipping voltage)	V a.c./d.c.	132	270	480	825
Opening time growth factor		1.1 ... 1.5			
Operating temperature	°C	-20 ... +70			
Connection to the coil terminals (parallel mounting)		Clip-on for both fixing and connection.			
Fixing		Clipped onto the top part of the contactor base without change in contactor overall dimensions.			
Advantages		High energy absorption: good damping - Unpolarized system.			
Drawback		Clipping as from U_{vdr}^* , thus voltage front up to this point.			

* U_{vdr} = Varistor operating voltage (voltage dependent resistor), tolerance $\pm 10\%$.

RC type		RC 5-1/50 RC 5-2/50	RC 5-1/133 RC 5-2/133	RC 5-1/250 RC 5-2/250	RC 5-1/440 RC 5-2/440
Control voltage U_c	V a.c.	24 ... 50			
Residual overvoltage (clipping voltage)	V a.c.	2 to 3 x U_c max.			
Opening time growth factor		1.2 ... 1.3			
Operating temperature	°C	-20 ... +70			
Connection to the coil terminals (parallel mounting)		Clip-on for both fixing and connection.			
Fixing		Clipped onto the top part of the contactor base without change in contactor overall dimensions.			
Advantages		Very fast clipping - Attenuation of steep fronts and thus of high frequencies. No operating delays.			

Wiring Diagrams

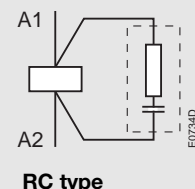
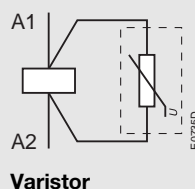
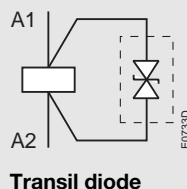

Dimensions

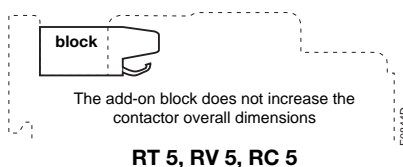

Impulse Contact blocks

Lamp Holder - Fuse Holder

CB 5... Impulse Contact Blocks

Application

Impulse contact blocks are available in two different types:
CB 5-10: N.O. contact with a black pushbutton ("ON" function),
CB 5-01: N.C. contact with a red pushbutton ("OFF" function).

Description

These blocks are equipped with 2 connecting leads 0.5 mm² with end, approximately 10 cm long.
 Mounting: Clipped onto the front face of the contactors.

Ordering details

For contactors	Contacts	Type	Order code	Pack ^{ing} pieces	Weight kg
A 9 ... A 110	1 –	CB 5-10	1SBN 010 013 R1010	1	0.012
	– 1	CB 5-01	1SBN 010 013 R1001	1	0.012

Note: The CB 5-10 and CB 5-01 blocks provided for the A... contactors can be used for the AF, AL, AL..Z, AE, TAL, TAE, UA, GA and GAE types.

BL 5-L Lamp Holder Block

Application: Lamp holder for indicator light.

Description

Block designed to hold a bulb, not supplied (BA 9 s type, max. P = 1.2 W, max. voltage = 400 V, max. length = 28 mm).
 Equipped with 2 connecting leads (1 mm² and approximately 10 cm long), with 3 lenses (green, red, colourless) for fixing on the front face of the d.o.l. starter enclosures (insulated enclosures).
 Mounting: Clipped onto the front face of the contactors.

Ordering details

For contactors	Type	Order code	Pack ^{ing} pieces	Weight kg
A 9 ... A 110, N	BL 5-L	1SBN 070 054 R1000	1	0.022

Note: The BL 5-L block provided for the A... contactors and N... contactor relays can be used for the AF, AL, AL..Z, AE, TAL, TAE, UA, GA, GAE, NL, NL Z, and TNL types.

BL 5-F Fuse Holder Block

Application: Fuse holder for the control circuit.

Description

Block designed to hold a fuse cartridge (5 x 20, 4 A max.), not supplied.
 Equipped with 2 connecting leads 1 mm² and approximately 10 cm long.
 Mounting: Clipped onto the front face of the contactors.

Ordering details

For contactors	Type	Order code	Pack ^{ing} pieces	Weight kg
A 9 ... A 110, N	BL 5-F	1SBN 070 055 R1000	1	0.020

Note: The BL 5-F block provided for the A... contactors and N... contactor relays can be used for the AF, AL, AL..Z, AE, TAL, TAE, UA, GA, GAE, NL, NL Z, and TNL types.

Dimensions (in mm)

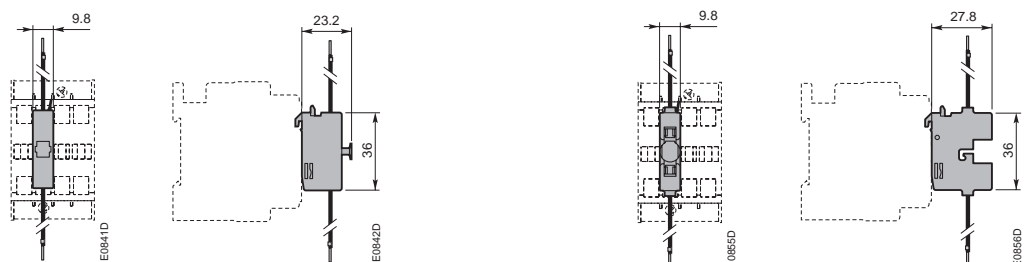

CB 5... Impulse contact blocks

BL 5-L Lamp holder blocks
 BL 5-F Fuse holder blocks



BA 5-50 Function Markers

BP 16 Mounting Piece



BA 5-50

1SBCS 7587 4F0301



BP 16

1SBCS 8672 4F0302

BA 5-50 Function Markers

Application

For marking contactors, thermal O/L relays, contactor relays and accessories.

Description

The **BA 5-50** is a set of 50 function markers designed to be clipped onto the front face of devices. Effective marking surface: 7 x 19 mm. Details can be added to these markers using a ball point pen, indelible felt-tip pen or pentel white. Self-adhesive labels (not supplied) can also be added to them.

Ordering details

For contactors	Type	Order code	Pack ^{ing} box	Weight kg
Contactors, thermal O/L relays, contactor relays and accessories	BA 5-50	1SBN 110 000 R1000	1	0.017

BP 16 Mounting Piece

Application

Mounting piece for screw fixing (M4, not supplied) of A... series contactors indicated in the table below. Easy handling of screwdrivers and screw driving.

Description

Add-on mounting piece on contactor's rear face, offering a wide fixing facility.

Ordering details

For contactors	Type	Order code	Pack ^{ing} pieces	Weight kg
A 9 ... A 16, AL 9 ... AL 16, AL 9Z ... AL 16Z, TAL 9 ... TAL 16, UA 16, UA 16..RA, N, NL, NL Z and TNL	BP 16	1SBN 111 403 R1000	100	0.141

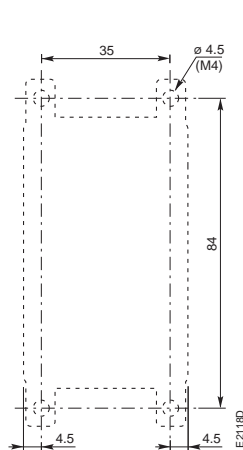

Drilling plan for A 9 ... A 16 , UA 16, UA16..RA, N contactors with BP 16

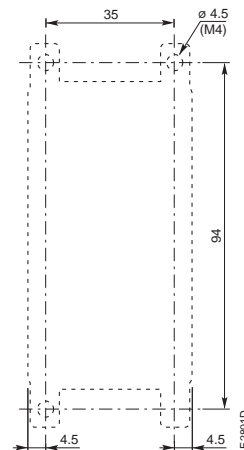

Drilling plan for AL 9 ... AL 16, AL 9Z ... AL 16Z, TAL 9 ... TAL 16, NL, NL Z and TNL contactors with BP 16

RA 5 Interface Relay



RA 5



A 50-30-00 + RA 5

Application

RA 5 interface relay is designed to receive 24 V d.c. signals delivered by PLC's or other sources **with a low output power** and to restore them with **sufficient power** to operate the coils of the relevant **A 9 ... A 75** contactors or the **N...** contactors relays.

Description

RA 5 interface relay is made up of a miniature electromechanical relay equipped with a N.O. contact and with a low consumption 24 V d.c. coil.

The interface relay coil is controlled by the PLC while the N.O. contact ensures switching of the power contactor.

Coil switching gives rise to overvoltages which have adverse effects on the electronic devices, insulators and, more generally, on component lifetime. The RA 5 is equipped with surge suppressors:

- on the 24 V d.c. relay coil via a diode,
- on the power contactor coil via a varistor.

Furthermore, the RA 5 is protected against relay pole reversal by a diode inserted between the E1 and E2 input terminals.

Connection

The "E1+" and "E2-" input terminals must be connected, according to their polarity, to the PLC output.

The **RA 5** is equipped with two terminal pads for connection to the A1 and A2 terminals of the contactor coil. This coil is supplied between the A0 and A2 terminals of the RA 5.

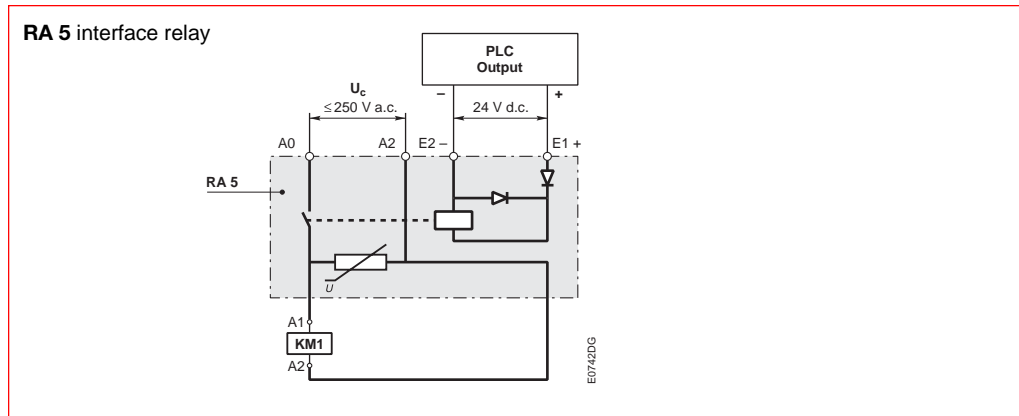

Mounting

Terminal pads clamped inside the contactor coil terminals.

Ordering Details

For contactors	Coil voltages	Control voltage U_c	Type	Order code	Pack ^{ing} pieces	Weight kg
A 9 ... A 75, N	24 ... 250 V / 50-60 Hz	24 V d.c.	RA 5	1SBN 060 000 R1001	1	0.050

Notes: The interface relays provided for the A... contactors can be used for the UA, UA..RA and GA types.
For A95, A110 contactors use R1561 interface relay. Specific catalogue available on request.

>> Dimensions section 9

RA 5 Interface Relays

Technical Data

General technical data

Compliance with standards		IEC 60255-5
Rated insulation voltage U_i according to IEC 60947-4-1	V a.c.	250
Permissible ambient temperature: – for free air operation: – at $U_e = 24$ V d.c. (between E1 and E2)	°C	-25 ... +70
– from 0.85 to $1.1U_e$	°C	-25 ... +55
– for storage	°C	-40 ... +70
Climatic withstand		Complies with that of associated contactors
Operating altitude	m	≤ 3000
Mounting position		No limitation
Fixing		Using the contactor A1 and A2 terminal connecting parts
Connecting terminals (delivered in open position)		M3.5 (+,-) pozidriv 2 screws with cable clamp
Connecting capacity (min. ... max.) – rigid solid	2 x mm²	1 ... 4
– flexible with cable end	2 x mm²	0.75 ... 2.5
Tightening torque – recommended	Nm	1.00
– max.	Nm	1.20
Degree of protection acc. to IEC 60947-1/EN 60947-1 and IEC 60529/EN 60529		Protection against direct contact in acc. with EN 50274

Working data

Surge suppression: – for contactor coil – for interface relay coil		Varistor Diode
Protection against polarity reversal between terminals E1 and E2		Diode
Interface relay operating time	ms	Closing and drop-out ≤ 10
Total operating time, interface relay + contactor: – between energization and: N.O. contact closing	ms	19 ... 36
N.C. contact opening	ms	16 ... 32
– between de-energization and: N.O. contact opening	ms	15 ... 25
N.C. contact closing	ms	18 ... 28

Electrical input data

Control voltage (E1 and E2 terminals) U_e – rated value	V d.c.	24
– max. range	V d.c.	17 ... 30
Max. consumption for $U_e = 24$ V d.c., $\theta = 20$ °C	W	0.3
"0" status (relay open) for U_e or I_e	V d.c. mA	≤ 2.4 < 1
"1" status (relay closed) for U_e	V d.c.	≥ 17
Max. short supply interruption immunity time	ms	4

Electrical output data

Switching voltage (A0 and A2 terminals)	V a.c.	≤ 250
Electrical durability million of operating cycles		2 (600 cycles/h) on A 9 ... A 40 contactors or N... contactor relay 1 (600 cycles/h) on A 45 ... A 75 contactors

LT... Terminal Shrouds

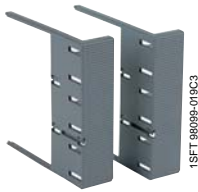

LT ...-AC

1SFN 98099-019C3

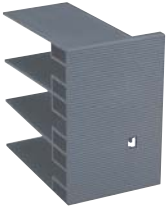

LT ...-AL

1SFN 98099-125



LT ...-AY

1SFN 98000-014

Application

Main terminal protection for **A 145 ... AF 750** contactors.

The auxiliary contact blocks and coils are designed to provide an IP 20 degree of protection.

The main terminals, equipped with lugs or connectors, can be protected against accidental direct contact after wiring (EN 50274) by the addition of terminal shrouds (see table below).

Note: A 9 ... A 110 contactors do not require additional terminal shrouds as their terminals are all already protected against accidental direct contact in acc. with EN 50274.

Description

Each terminal shroud protects all the terminals on one side of the contactor. Two terminal shrouds should be provided for each separate contactor.

Ordering Details

For contactors	Type	Order code	Pack ^{ing} pieces	Weight kg 1 piece
A 145 ... A 185 with connectors	LT 185-AC	1SFN 124 701 R1000	2	0.050
A 145 ... A 185 with lugs	LT 185-AL	1SFN 124 703 R1000	2	0.220
A 145 ... A 185 with short. bar LY 185 or between A 145 and TA 200DU or between A 185 and TA 200DU	LT 185-AY	1SFN 124 704 R1000	1	0.050
A 210 ... A 300 with connectors	LT 300-AC	1SFN 125 101 R1000	2	0.070
A 210 ... A 300 with lugs	LT 300-AL	1SFN 125 103 R1000	2	0.280
A 210 ... A 300 with short. bar LY 300	LT 300-AY	1SFN 125 104 R1000	1	0.075
AF 400 ... AF 460 with connectors	LT 460-AC	1SFN 125 701 R1000	2	0.100
AF 400 ... AF 460 with lugs	LT 460-AL	1SFN 125 703 R1000	2	0.800
AF 580 ... AF 750 with connectors	LT 750-AC	1SFN 126 101 R1000	2	0.120
AF 580 ... AF 750 with lugs	LT 750-AL	1SFN 126 103 R1000	2	0.825

Note: The shrouds provided for the A... contactors can be used for the AF... types.

>> Dimensions section 9

LK... Terminals for Control Lead Connections



1SBG5 7576 3F0301

LK 75-L



1SBG5 7577 3F0301

LK 75-F



1SBG5 7575 3F0301

LK 110

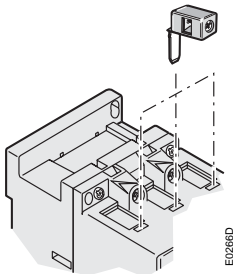

E0288D

LK ... positioning

Application

Terminals designed to connect the control conductors to the main poles of the **A 45 ... A 110** contactors and derivative versions.

Description

Accessories clipped into the slots placed above each power terminal connector.

The **LK 75...** are fitted with a pin designed to hold them in place until the connector has been fully clamped with its power cable.

The **LK 110** must be held in place until the connector has been clamped.

- Degree of protection IP 20
- Connecting terminal delivered in open position: cable clamp and M 3.5 (+,-) pozidriv 2 screw.
- Cable cross-sectional area:

– 1 or 2 rigid conductors	1 ... 4 mm ²
– 1 or 2 flexible conductors with cable end	0.75 ... 2.5 mm ²
- Tightening torque for the LK... screw:

– recommended	1.00 Nm
– maxi.	1.20 Nm

Ordering Details

Connection	Type	Order code	Pack ^{ing} pieces	Weight kg 1 piece
Right and left on A 45 ... A 75	LK 75-L	1SBN 073 552 R1003	2	0.006
Opposite on A 45 ... A 75	LK 75-F	1SBN 073 552 R1002	2	0.006
Right and left on A 95 ... A 110	LK 110	1SFN 074 352 R1000	2	0.010

Note: The LK... terminals provided for the A... contactors can be used for the AF, AE, AM, TAE, UA, GA and GAE types.

Dimensions (in mm)

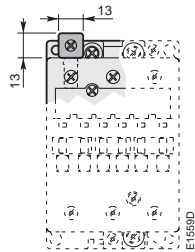

E1658D

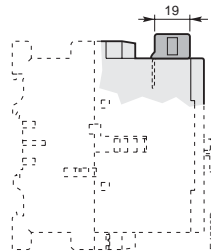

E 1658D

LK 75-L, LK 110

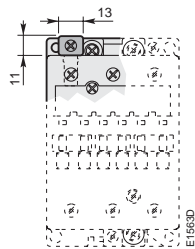

E1663D

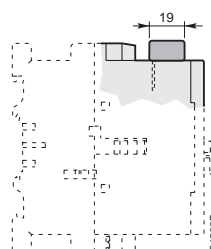

E 1662D

LK 75-F

LZ... Connector Terminals

LZ... Connector Terminals for Al and Cu Cables

Application

Connection of copper and aluminium cables to the terminal pads of the poles of A and AF contactors.

Ordering details

Cables	For contactors	Cable cross section mm ²	Type	Order code	Pack ^{ing} set	Weight kg 1 piece
Single, Cu	A 145, A 185	6...185	–	1SDA 023 354 R0001	3	0.200
	A 210 ... AF 460	16...240	–	1SDA 023 368 R0001	3	0.400
Single Al & Cu	A 145, A 185	35...95	–	1SDA 023 356 R0001	3	0.100
	A 145, A 185	25...150	–	1SDA 023 357 R0001	3	0.100
	A 210 ... A 300	120...240	–	1SDA 023 370 R0001	3	0.200
Double, Cu	A 145, A 185	2x(50...120)	LZ 185-2C/120	1SFN 074 709 R1000	3	0.300
	A 210 ... A 300	2x(95...120)	–	1SDA 025 766 R0001	3	0.400
Al & Cu	AF 400 ... AF 750	2x(120...240)	–	1SDA 023 380 R0001	3	0.110
Triple Al & Cu	AF 400 ... AF 750	3x(70...185)	–	1SDA 023 384 R0001	3	0.265
Multi Al & Cu	AF 1350, AF 1650	4x(120...240)	–	1SDA 023 387 R0001	3	0.400

Note: Connectors provided for the A... contactors can be used for the AF types.



1SFT 98099-011C1

LZ...



1SFT 98099-095C2



1SBC5 8054 2F0302

LZ...

LD... Additional Terminal Blocks



A 9-30-10 with LD 16



LD 16



LD 26



LD 40



LD 75



LD 110

Application

The **LD...** terminal block is designed to increase the connecting capacity of the contactor on which it is fitted and for preparation of the wiring before final connection on the contactor.

Description

The **LD...** blocks are 3-pole terminal blocks with tunnel terminals. The available range can be used on A 9 to A 110 contactors.

The **LD75** and **LD110** terminal blocks are fixed in the 3 independent slots located above the built-in connectors.

Ordering Details

For contactors	Type	Order code	Pack ^{ing} pieces	Weight kg 1 piece
A 9 ... A 16	LD 16	1SBN 071 408 R1000	2	0.030
A 26	LD 26	1SBN 072 408 R1000	2	0.040
A 30, A 40	LD 40	1SBN 072 808 R1000	1	0.075
A 45, A 75	LD 75	1SBN 073 508 R1000	1	0.115
A 95, A 110	LD 110	1SFN 074 308 R1000	1	0.150

Note: The LD... terminal blocks provided for the A... contactors can be used for the AF, AL, AL...Z, AE, TAL, TAE and UA types.

Technical Data

Types	LD 16	LD 26	LD 40	LD 75	LD 110
Rated insulation voltage U_i according to IEC 60947-5-1	V 690				
according to UL / CSA	V 600				
Connecting terminals					
with single connector	mm 6x6	6x7	8x10	10x11	12x12
Connecting capacity (min. ... max.)					
Rigid solid ($\leq 4 \text{ mm}^2$) } \Rightarrow 1 x mm ²	1.5 ... 16	2.5 ... 16	4 ... 35	6 ... 50	10 ... 70
stranded ($\geq 6 \text{ mm}^2$) } \Rightarrow 2 x mm ²	1.5 ... 6	2.5 ... 6	4 ... 16	6 ... 25	10 ... 35
Flexible with cable end					
\Rightarrow 1 x mm ²	1.5 ... 16	2.5 ... 16	4 ... 25	6 ... 35	10 ... 50
\Rightarrow 2 x mm ²	1.5 ... 4	2.5 ... 4	4 ... 10	6 ... 16	10 ... 25
Bars	mm 6	6.5	8	10	12
Screw terminals (delivered in closed position)	(+,-) pozidriv 2 M4 M5 M6				Hexagon socket M8 (S = 4 mm)
Tightening torque (cable connection)	Nm 1.7	2.5	2.5	4	6
Degree of protection acc. to IEC 60947-4-1, EN 60947-4-1, IEC 60529 and EN 60529	IP 10				

Note: The utilization of **LD...** additional terminal blocks keeps the possibility to connect the following cables directly in the contactor main terminals but the **BED** and **BEM** connecting sets can no longer be used.

Possible cross section of rigid cable in the contactor terminals	LD 16	LD 26	LD 40	LD 75	LD 110
mm ²	4	6	10	50	95

>> Dimensions section 9

LX... Terminal Extension

LW... Terminal Enlargement

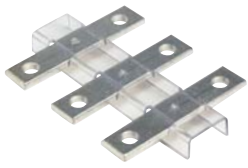

1SFT 98000-012C3

LX...

LX... Terminal Extension Pieces

Application

Extension pieces designed to extend the main terminals of contactors for combined mounting of connectors and connection sets.

Description

Sets containing 3 tin plated copper bars fixed by an isolating spacer.

Ordering details

For contactors	Dimensions hole Ø mm	bar mm	Type	Order code	Pack ^{ing} set	Weight kg 1 set
A 145, A185	8.5	17.5 x 5	LX 185	1SFN 074 710 R1000	1	0.250
A 210 ... A 300	10.5	20 x 5	LX 300	1SFN 075 110 R1000	1	0.350
AF 400, AF 460	10.5	25 x 5	LX 460	1SFN 075 710 R1000	1	0.500
AF 580, AF 750	13	40 x 6	LX 750	1SFN 076 110 R1000	1	0.850

Note: The LX... pieces provided for the A... contactors can be used for the AF types.

LW... Enlargement Pieces

Application

Enlargement pieces designed to increase the width of the contactor terminal pads in order to allow larger connectors to be mounted.

Description

Sets containing 3 tin plated copper bars fixed by an isolating spacer.

Ordering details

For contactors	Dimensions hole Ø mm	bar mm	Type	Order code	Pack ^{ing} set	Weight kg 1 set
A 95, A 110	6.5	15 x 3	LW 110	1SFN 074 307 R1000	1	0.100
A 145, A 185	10.5	17.5 x 5	LW 185	1SFN 074 707 R1000	1	0.250
A 210 ... A 300	10.5	20 x 5	LW 300	1SFN 075 107 R1000	1	0.450
AF 400, AF 460	10.5	25 x 5	LW 460	1SFN 075 707 R1000	1	0.730
AF 580, AF 750	13	40 x 6	LW 750	1SFN 076 107 R1000	1	1.230

Note: The LW... pieces provided for the A... contactors can be used for the AF, AE, TAE and UA types.

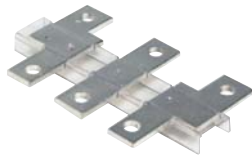

1SFT 98000-011C3

LW...

Terminal Connecting Strips and Shorting Bars



Application

Parallel and series connection of 3-pole and 4-pole contactor poles:

- To obtain a star point (3 parallel-connected poles): **LY**, **LF**, (LY allows 3 phases to be short-circuited).
- To connect poles in parallel and thus increase the a.c. load passing through the flow path made up of the parallel-connected poles: **LP** and **LH** (2 poles); **LY** and **LF** (3 poles); **LG** (4 poles).
For the maximum permissible current values with parallel-connected poles see "Parallel Connection of Main Poles".
The relevant cable cross-sectional area may limit the maximum permissible current. Consult the information in the table below.
- To connect poles in series and thus increase the d.c. load controlled by the poles: **LP** and **LH**.

Description

Types	for connection of "n" poles	with terminal	insulated
LP...	n = 2	no	yes (1)
LY...	n = 3	no	yes (1)
LH...	n = 2	yes	no
LF...	n = 3	yes	no
LG...	n = 4	yes	no

(1) LP 185 ... LP 750, LY 185 ... LY 750 not insulated. Use terminal shrouds.

Ordering Details

For contactors	max. nominal continuous current with "n" poles A	Cable cross-sectional area mm ²	Type	Order code	Pack ¹⁰⁹ pieces	Weight kg
						1 piece
A 9	30	6	LP 16	FPEP 407 000 R0001	10	0.002
A 12	32	6				
A 16	34	6				
N	–	6				
A 26	50	–	LP 25	FPEP 407 001 R0001	10	0.004
A 145, A 185	300	–	LP 185	1SFN 074 712 R1000	2	0.300
A 210 ... A 300	475	–	LP 300	1SFN 075 112 R1000	2	0.400
AF 400, AF 460	725	–	LP 460	1SFN 075 712 R1000	2	0.550
AF 580, AF 750	1200	–	LP 750	1SFN 076 112 R1000	2	0.950
A 9	33	6	LY 16	FPEP 407 002 R0001	10	0.005
A 12	36	6				
A 16	39	6				
A 95, A 110	240	–	LY 110	1SFN 074 303 R1000	1	0.055
A 145, A 185	400	–	LY 185	1SFN 074 703 R1000	1	0.200
A 210 ... A 300	670	–	LY 300	1SFN 075 103 R1000	1	0.300
AF 400, AF 460	1000	–	LY 460	1SFN 075 703 R1000	1	0.450
AF 580, AF 750	1650	–	LY 750	1SFN 076 103 R1000	1	0.800
A 9	35	10	LH 16	FPTN 477 017 R0001	2	0.010
A 12	38	10				
A 16	45	10				
A 26	72	16	LH 25	FPTN 472 669 R0001	2	0.014
A 45 ... A 75	200	95	LH 75	FPTN 472 734 R0001	2	0.085
A 9	50	16	LF 16	FPTN 477 017 R0002	2	0.010
A 12	54	16				
A 16	63	16				
A 26	100	35	LF 26	1SBN 072 405 R1000	2	0.022
A 30, A 40	140	50	LF 40	1SBN 073 205 R1000	2	0.037
A 45 ... A 75	275	150	LF 75	FPTN 472 735 R0001	2	0.095
A9	62	16	LG 16	FPTN 477 017 R0003	2	0.012
A 12	67	16				
A 16	72	16				

Note: – The strips and shorting bars provided for the A... contactors can be used for the AF, AL, AL.Z, AE, TAL and TAE types.
– The strips provided for the N... contactors relays can be used for the NL, NL Z and TNL types.

>> Parallel Connection of Main Poles page 2/90

>> Terminal Shrouds page 4/20

Connection Sets

Connections for Reversing Contactors

Application

Connections between the main poles of **two 3-pole contactors** mounted side by side as reversing contactors.

Description

The sets are made up of three upstream connections and three downstream connections.

BEM 16-30

– Insulated, solid, rigid copper wires

BEM 26-30, BEM 40-30

– Insulated, stranded, rigid copper wires

BEM 75-30 ... BEM 750-30

– Insulated, solid copper bars

On the **A...** contactors, the power supply by bars or cables equipped with lugs is directly connected to the terminal pads of the main poles. For flange connectors, **LX...** terminal extension pieces should be used.

Ordering details

Mounting on 3-pole contactors	Type	Order code	Pack ^{ing} set	Weight kg 1 set
A 9 ... A 16	BEM 16-30	1SBN 081 401 R1000	1	0.025
A 26	BEM 26-30	1SBN 082 401 R1000	1	0.056
A 30, A 40	BEM 40-30	1SBN 082 801 R1000	1	0.096
A 50 ... A 75	BEM 75-30	1SBN 083 501 R1000	1	0.243
A 95, A 110	BEM 110-30	1SFN 084 301 R1000	1	0.450
A145, A 185	BEM 185-30	1SFN 084 701 R1000	1	0.900
A 210 ... A 300	BEM 300-30	1SFN 085 101 R1000	1	1.100
AF 400, AF 460	BEM 460-30	1SFN 085 701 R1000	1	4.400
AF 580, AF 750	BEM 750-30	1SFN 086 101 R1000	1	7.300

Note: The connections provided for the A... contactors can be used for the AF, AL, AL..Z, TAL, AE and TAE types.

3-pole Connections Phase to Phase

Application

Connections between the main poles of **two 3-pole contactors** horizontal mounted.

Description

This set is made up of three downstream or upstream connections.

Ordering details

Mounting on 3-pole contactors	Type	Order code	Pack ^{ing} set	Weight kg 1 set
A 50 ... A 75	BES 75-30	1SBN 083 504 R1000	1	0.130
A 95, A 110	BES 110	1SFN 084 304 R1000	1	0.250
A 145, A 185	BES 185	1SFN 084 704 R1000	1	0.500
A 210 ... A 300	BES 300	1SFN 085 104 R1000	1	1.000
AF 400, AF 460	BES 460	1SFN 085 704 R1000	1	2.200
AF 580, AF 750	BES 750	1SFN 086 104 R1000	1	3.700

Note: The connections provided for the A... contactors can be used for the AF, AE and TAE types.

Connections for 4-pole Changeover Contactors

Application

Connection between the main poles of **two 4-pole contactors** mounted side by side so that they operate as source reversing contactors.

Description

These sets are made up of four downstream connections, with insulated, stranded, rigid copper cables.

Ordering details

Mounting on 4-pole contactors	Type	Order code	Pack ^{ing} set	Weight kg 1 set
A 45, A 50, A 75	BES 75-40	1SBN 083 302 R1000	1	0.400

Note: The connections provided for the A... contactors can be used for the AF, AE and TAE types.

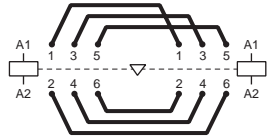

BEM... connections

EG744D

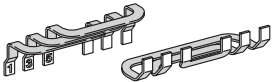

BEM 75-30

EG618D1



BEM 300-30

1SFT 98001-011C3

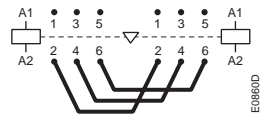

BES... for 3-pole connections

EG696D



BES...

1SFT 98000-009C6

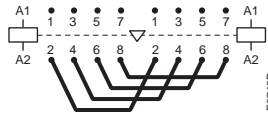

BES... for 4-pole connections

EG753D

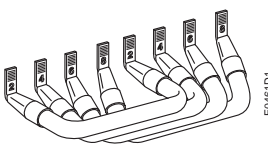

BES 75-40

EG461D1

BED... Connection Sets

Connections for Star-Delta Starters

Application

Connections between the main poles of a star-delta starter.

Description

These sets are made up of:

- Three line contactor / delta contactor connections - Upstream side.
- Three connections for star and delta contactors - Downstream side.
- The necessary elements to create the star point upstream of the star contactor.

- BED 16 / BED 16-1, BED 26 / BED 26-1** - Insulated, solid copper wires.
- BED 40 / BED 40-1** - Insulated, stranded solid copper wires.
- BED 50 / BED 50-1, BED 75 / BED 75-1** - Solid copper bars and insulated stranded copper wires.
- BED 95 ... BED 750** - Insulated, solid copper bars.

BED 16-1 ... BED 75-1 connection sets are designed for star and delta contactors **without mechanical interlock unit** (contactors mounting joined side by side).

For **mechanically interlocked** star and delta contactors use **BED 16 ... BED 75** connection sets.

BED 95 ... BED 750 are designed for both star and delta contactors **with or without mechanical interlock unit**.

Ordering details

For contactors		Interlock unit between star and delta contactors	Type	Order code	Weight kg Pack ^{ing} 1 set	
Line and Delta	Star					
A 9	A 9	-	BED 16-1	1SBN 081 403 R1001	0.040	
A 12	A 9		BED 16	1SBN 081 403 R1000	0.040	
A 16	A 12		VM / VE 5-1			
A 26	A 16	-	BED 26-1	1SBN 082 403 R1001	0.045	
			VM / VE 5-1	BED 26	1SBN 082 403 R1000	0.050
A 30	A 26	-	BED 40-1	1SBN 082 803 R1001	0.070	
A 40	A 26		VM / VE 5-1	BED 40	1SBN 082 803 R1000	0.070
A 50	A 30		BED 50-1	1SBN 083 503 R1001	0.180	
A 63	A 40	VE 5-2	BED 50	1SBN 083 503 R1000	0.280	
			BED 75-1	1SBN 084 103 R1001	0.180	
A 75	A 50	VE 5-2	BED 75	1SBN 084 103 R1000	0.250	
A 95	A 75	VE 5-2	BED 95	1SFN 084 303 R1000	0.400	
A 110	A 95	VE 5-2	BED 110	1SFN 084 503 R1000	0.500	
A 145	A 110	VM 300H	BED 145 A	1SFN 084 703 R1000	1.300	
A 185	A 145	VM 300H	BED 185	1SFN 084 903 R1000	1.100	
A 210	A 185	VM 300H	BED 210	1SFN 085 103 R1000	1.500	
A 260	A 210	VM 300H	BED 300	1SFN 085 303 R1000	2.100	
A 300	A 260					
AF 400	A 260	VM 300/460H	BED 400	1SFN 085 503 R1000	3.500	
AF 460	A 300					
AF 460	AF 400	VM 750H	BED 460	1SFN 085 703 R1000	4.700	
AF 580	AF 400					
AF 580	AF 460	VM 750H	BED 580	1SFN 085 903 R1000	6.300	
AF 750	AF 580					
AF 750	AF 580	VM 750H	BED 750	1SFN 086 103 R1000	7.700	

Note: The connections provided for A... contactors can be used for the AL, AL..Z, AE, TAL and TAE types.

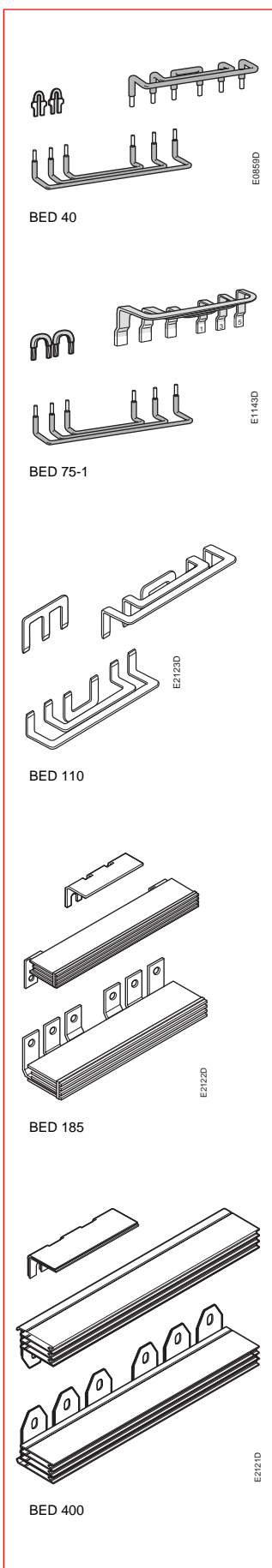

BEA 16 ... BEA 110 Connecting Links and PM26... Mounting Plates for Contactors and Manual Motor Starters

Application

The **BEA...** connecting link is used to connect a contactor to an associated manual motor starter. These are then used together as **DOL** or **Reversing Starters** in type 1 or type 2 coordination, complying with IEC 60947-4-1 and EN 60947-4-1. See Database of coordination tables on the ABB Website: www.abb.com/lowvoltage Right menu, select: "Support" and select: "Online Product Selection Tools".

The **PM26...** mounting plates are used, with the **BEA...** connecting link, to create secure DOL and Reversing Starters.

Description

The **BEA...** insulated 3-pole connecting link (touch safe) ensures the electrical linking between the contactor and the corresponding manual motor starter.

Two **PM26...** mounting plates are available to suit the type of motor starting: **PM26-13** single mounting plate for DOL Starters or **PM26-23** double adjustable mounting plate for Reversing Starters.

The products are mounted onto the plate without the need for screws, they are simply clipped into position.

Selection Table

Direct-On-Line Starter

I _e max. AC-3, 400 V A	Contactor & fixing Screws not supplied	Connecting link	MMS & fixing Screws / Rail not supplied	Mounting plate
9	A 9 AL 9	BEA 16/116 BEA 16/116AL	MS116 15x35 mm	—
12	A 12 AL 12	BEA 16/116 BEA 16/116AL	MS116 15x35 mm	—
16	A 16 AL 16	BEA 16/116 BEA 16/116AL	MS116 15x35 mm	—
16	A 26	BEA 26/116	MS116	PM26-13
9	A 9 AL 9	BEA 16/325 BEA 16/325AL	MS325 15x35 mm	—
12	A 12 AL 12	BEA 16/325 BEA 16/325AL	MS325 15x35 mm	—
16	A 16 AL 16	BEA 16/325 BEA 16/325AL	MS325 15x35 mm	—
25	A 26 AL 26	BEA 26/325 BEA 26/325AL	MS325	PM26-13
32	A 30 2 x M4	BEA 40/450	MS 450 2 x M5	—
37	A 40 2 x M4	BEA 40/450	MS 450 2 x M5	—
50	A 50 2 x M4	BEA 50/450	MS 450 2 x M5	—
50	A 50 2 x M6	BEA 75/495	MS 495 2 x M5	—
63	A 63 2 x M6	BEA 75/495	MS 495 2 x M5	—
75	A 75 2 x M6	BEA 75/495	MS 495 2 x M5	—
90	A 95 2 x M6	BEA 110/495	MS 495 2 x M5	—
100	A 110 2 x M6	BEA 110/495	MS 495 2 x M5	—

Reversing Starter

I _e max. AC-3, 400 V A	Contactors & fixing Screws not supplied	Connecting link	MMS & fixing Screws not supplied	Connection set for the contactors	Interlock unit (see "Accessory Fitting Details")	Mounting plate
9	2 x A 9 2 x AL 9	BEA 16/116 BEA 16/116AL	MS116	BEM 16-30	VM 5-1 / VE 5-1	PM26-23
12	2 x A 12 2 x AL 12	BEA 16/116 BEA 16/116AL	MS116	BEM 16-30	VM 5-1 / VE 5-1	PM26-23
16	2 x A 16 2 x AL 16	BEA 16/116 BEA 16/116AL	MS116	BEM 16-30	VM 5-1 / VE 5-1	PM26-23
16	2 x A 26	BEA 26/116	MS116	BEM 26-30	VM 5-1 / VE 5-1	PM26-23
9	2 x A 9 2 x AL 9	BEA 16/325 BEA 16/325AL	MS325	BEM 16-30	VM 5-1 / VE 5-1	PM26-23
12	2 x A 12 2 x AL 12	BEA 16/325 BEA 16/325AL	MS325	BEM 16-30	VM 5-1 / VE 5-1	PM26-23
16	2 x A 16 2 x AL 16	BEA 16/325 BEA 16/325AL	MS325	BEM 16-30	VM 5-1 / VE 5-1	PM26-23
25	2 x A 26 2 x AL 26	BEA 26/325 BEA 26/325AL	MS325	BEM 26-30	VM 5-1 / VE 5-1	PM26-23
32	2 x A 30 4 x M4	BEA 40/450	MS 450 2 x M5	BEM 40-30	VM 5-1 / VE 5-1	—
37	2 x A 40 4 x M4	BEA 40/450	MS 450 2 x M5	BEM 40-30	VM 5-1 / VE 5-1	—
50	2 x A 50 4 x M4	BEA 50/450	MS 450 2 x M5	BEM 75-30	VE 5-2	—
50	2 x A 50 4 x M6	BEA 75/495	MS 495 2 x M5	BEM 75-30	VE 5-2	—
63	2 x A 63 4 x M6	BEA 75/495	MS 495 2 x M5	BEM 75-30	VE 5-2	—
75	2 x A 75 4 x M6	BEA 75/495	MS 495 2 x M5	BEM 75-30	VE 5-2	—
90	2 x A 95 4 x M6	BEA 110/495	MS 495 2 x M5	BEM 110-30	VE 5-2	—
100	2 x A 110 4 x M6	BEA 110/495	MS 495 2 x M5	BEM 110-30	VE 5-2	—



A 9-30-10 + BEA 16/116 + MS 116
DOL Starter



A 26-30-10 + BEA 26/325 + MS 325
+ PM26-13 DOL Starter

BEA 16 ... BEA 110 Connecting Links and PM26.. Mounting Plates for Contactors and Manual Motor Starters



BEA 16/116

1SBCE 8281 3F0301

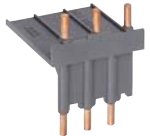

BEA 40/450

1SBCE 8276 3F0301



PM26-13

1SBCE 9080 3F0302



PM26-23

1SBCE 9079 3F0302

Ordering Details

Connecting links

For contactors	For MMS	Type	Order code	Pack ^{ing} pieces	Weight kg 1 piece
A 9, A 12, A 16	MS 116	BEA 16/116	1SBN 081 406 R1000	10	0.020
AL 9, AL 12, AL 16	MS 116	BEA 16/116AL	1SBN 081 406 R1003	5	0.027
A 26	MS 116	BEA 26/116	1SBN 082 406 R1000	10	0.024
A 9, A 12, A 16	MS 325	BEA 16/325	1SBN 081 406 R1001	10	0.031
AL 9, AL 12, AL 16	MS 325	BEA 16/325AL	1SBN 081 406 R1002	5	0.032
A 26	MS 325	BEA 26/325	1SBN 082 406 R1001	10	0.031
AL 26	MS 325	BEA 26/325AL	1SBN 082 406 R1002	10	0.033
A 30, A 40	MS 450	BEA 40/450	1SBN 083 206 R1000	1	0.061
A 50	MS 450	BEA 50/450	1SBN 083 506 R1000	1	0.062
A 50, A 63, A 75	MS 495	BEA 75/495	1SBN 084 106 R1000	1	0.120
A 95, A 110	MS 495	BEA 110/495	1SBN 084 506 R1000	1	0.124

The **BEA...** connecting links provided for the **A...** contactors can be used for the AF..., AE..., and TAE... types.
The **BEA../...AL** connecting links provided for the **AL...** contactors can be used for the AL...Z, and TAL... types.

Mounting plates

For contactors	For MMS	Type	Order code	Pack ^{ing} pieces	Weight kg 1 piece
1 x A 26	MS 116 MS 325	PM26-13	1SBN 092 406 R1000	2	0.160
2 x A 9 ... A 26	MS 116 MS 325	PM26-23	1SBN 091 407 R1000	1	0.330

The **PM26-..** mounting plates provided for the **A...** contactors can be used for the AL..., AL...Z and TAL... types.

Mounting Characteristics

The contactors and MMS are mounted onto the **PM26-..** plate without the need for screws, they are simply clipped into position.

The **PM26-..** mounting plates can be fixed into place either by 2 x 35 mm rail positioned 125 mm apart or by screws (see "Dimensions" for drilling plan). The plates can only be mounted in position 1 and 5 (see "Contactor Technical Data" for mounting position diagram)

>> Contactors	section 2	>> Interlock Units	page 4/10
>> MMS	section 5	>> Accessory Fitting Details	pages 2/8, 2/17
>> BEM... Connection Sets	page 4/26	>> Dimensions	section 9

Connection Bars for Contactor and MCCB

Connection Bars for Contactor and Switch fuse

Application

Connections between contactors/starters and moulded case circuit breakers or switch fuses.

Description

These connection sets are solid copper bars either isolated or protected by shrouds.

Ordering Details

Connection bars between contactor and MCCB

Vertical assembly

Contactors	MCCB	Type	Order code	Pack ^{ing} set	Weight kg 1 piece
A 145, A 185	T 3	BEA 185/T3	1SFN 084 706 R1003	1	0.150
A 145, A 185	S 3, S 4	BEA 185/S3/S4	1SFN 084 706 R1000	1	0.150
A 210	S 4	BEA 210/S4	1SFN 085 106 R1001	1	0.160
A 210 ... A 300	S 5	BEA 300/S5	1SFN 085 106 R1000	1	0.200
AF 400, AF 460	S 5	BEA 400/S5	1SFN 085 706 R1000	1	0.250
AF 400 ... AF 750	S 6	BEA 750/S6	1SFN 086 106 R1000	1	0.410

Vertical assembly with control wire terminals (Also suitable when using busbar kits for starter combinations)

A 145, A 185	T 3	BEA 185 D/T3	1SFN 084 706 R1004	1	0.175
A 145 ... A 185	S 3, S 4	BEA 185D/S3/S4	1SFN 084 706 R1002	1	0.200
A 210	S 4	BEA 210D/S4	1SFN 085 106 R1002	1	0.270
A 210 ... A 300	S 5	BEA 300D/S5	1SFN 085 506 R1002	1	0.320
AF 400, AF 460	S 5	BEA 400D/S5	1SFN 085 706 R1002	1	0.480
AF 400 ... AF 750	S 6	BEA 750D/S6	1SFN 086 106 R1002	1	0.720

Horizontal assembly (Also suitable when using busbar kits for starter combinations)

A 145, A 185	S 3, S 4	BEA 185H/S4	1SFN 084 707 R1000	1	0.520
A 210	S 4	BEA 210H/S4	1SFN 085 107 R1000	1	0.620
A 210, A 300	S 5	BEA 300H/S5	1SFN 085 307 R1000	1	1.280
AF 400, AF 460	S 5	BEA 400H/S5	1SFN 085 707 R1000	1	1.310
AF 400, AF 460	S 6	BEA 460H/S6	1SFN 085 907 R1000	1	2.450
AF 580, AF 750	S 6	BEA 750H/S6	1SFN 086 107 R1000	1	4.010

Note: The BEA... connection bars provided for the A 145 ... A 300 contactors can be used for the AF 145 ... AF 300 contactors.

Connection bars between contactor and switch fuse

Vertical assembly

Contactors	Switch fuse	Type	Order code	Pack ^{ing} set	Weight kg 1 piece
A 185	OESA 250	BEF 185/OESA250	1SFN 084 908 R1000	1	0.260
A210 ... A 300	OESA 250 to OESA 400	BEF 300/OESA400	1SFN 085 108 R1000	1	0.330
AF 400 ... AF 460	OESA 400	BEF 460/OESA400	1SFN 085 708 R1000	1	0.340
AF 460 ... AF 750	OESA 630 to OESA 800	BEF 750/OESA800	1SFN 086 108 R1000	1	0.740

Horizontal assembly

A 145	OS 160..LR	OSZA 15	1SCA 022 509 R0120	1	0.170
A 145, A 185	OESA 250..LR	BEF 185H/OESA250	1SFN 084 709 R1000	1	0.550
A 210 ... A 300	OESA 250..LR to OESA 400..LR	BEF 300H/OESA400	1SFN 085 109 R1000	1	1.200
AF 400, AF 460	OESA 400..LR	BEF 460H/OESA400	1SFN 085 709 R1000	1	1.250

Note: The BEF... connection bars provided for the A 145 ... A 300 contactors can be used for the AF 145 ... AF 300 contactors.



A 145-30 contactor + Tmax MCCB on top



BEA 300/S5

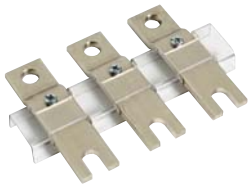

BEA...D/S

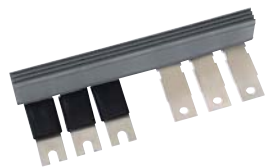

BEA 300H/S5



BEF 300/OESA400

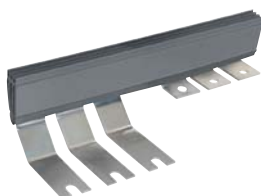

BEF 300H/OESA400

Adapter Plates and Mounting Plates for A 95 ... AF 750 Contactors

Application

Adapter plates and mounting plates with fixing holes for the specified contactors and overload relays.

Ordering Details

Adapter plates



PR300-1

1SFT 98001-015C3



PR400-2

1SFT 98001-014C3



PN300A-11

1SFT 98001-016C3



PN300-21

1SFT 98001-017C3



PN300-41

1SFT 98001-018C3

From old contactor	To new contactor	Type	Order code	Weight kg Pack ^{ing} 1 piece
EH 65,75, 80, 90, EG 80	A 95, A 110	PR 110-1	1SFN 094 500 R1000	0.270
EH 100, 145	A 110, A 145	PR 145-1	1SFN 094 700 R1000	0.360
EH 150, 160, 175, 210, EG 160	A 185, A 210	PR 210-1	1SFN 094 900 R1000	0.440
EH 250, 260, 300	A 210 ... A 300	PR 300-1	1SFN 095 300 R1000	0.560
EH 370, 550, EG 315	AF 400 ... AF 580	PR 460-1	1SFN 095 700 R1000	0.900
EH 700, 800	AF 750	PR 750-1	1SFN 096 100 R1000	0.500
OKYM 150, 175	A 185	PR 185-2	1SFN 095 100 R1001	0.500
OKYM 200, 250	A 210 ... A 300	PR 300-2	1SFN 095 300 R1001	0.500
OKYM 315	AF 400, AF 460	PR 400-2	1SFN 095 700 R1002	0.820
OKYM 400	AF 400, AF 460	PR 460-2	1SFN 095 700 R1001	0.800
OKYM 500	AF 580	PR 580-2	1SFN 096 100 R1002	0.700
EH 550, EG 630, OKYM 630	AF 580, AF 750	PR 750-2	1SFN 096 100 R1001	1.100

Mounting plates for Direct on Line Starters

For contactor	For overload relay	Type	Order code	Weight kg Pack ^{ing} 1 piece
A 145, A 185	TA 200 DU, E 200 DU	PN 185-11	1SFN 094 705 R1000	1.100
A 210, A 260, A 300	TA 450 DU, E 320 DU	PN 300A-11	1SFN 095 105 R1000	1.650
AF 400, AF 460	E 500 DU	PN 460-11	1SFN 095 705 R1000	2.120
AF 580, AF 750	E 800 DU	PN 750-11	1SFN 096 105 R1000	2.500

Mounting plates for mechanical interlocked contactors, reversing starters and two speed starters for double windings

For two contactors side by side with space for mechanical interlock	For one or two relays	Type	Order code	Weight kg Pack ^{ing} 1 piece
A 95, A 110	TA 80 DU, TA 110 DU	PN 110-21	1SFN 094 301 R1000	0.600
A 145, A 185	TA 200 DU, E 200 DU	PN 185-21	1SFN 094 701 R1000	1.800
A 210 ... A 300	TA 450 DU, E 320 DU	PN 300-21	1SFN 095 101 R1000	2.530
AF 400, AF 460	E 500 DU	PN 460-21	1SFN 095 701 R1000	3.490
AF 580, AF 750	E 800 DU	PN 750-21	1SFN 096 101 R1000	4.230

Mounting plates for Star-Delta Starters and two speed starters for single windings

For Main and Delta contactors	For Star contactor (1)	For Overload relays	Type	Order code	Weight kg Pack ^{ing} 1 piece
A 95, A 110	A 75, A 95	TA 80 DU or TA 110 DU	PN 110-41	1SFN 094 303 R1000	0.950
A 145, A 185	A 110, A 145	E 200 DU or TA 200 DU	PN 185-41	1SFN 094 903 R1000	2.440
A 210, 260, 300	A 185, A 210, A 260	E 320 DU or TA 450 DU	PN 300-41	1SFN 095 503 R1000	3.440
AF 400, AF 460	A 300, AF 400	E 500 DU	PN 460-41	1SFN 095 703 R1000	5.310
AF 580, AF 750	AF 400, AF 460, AF 580	E 800 DU	PN 750-41	1SFN 096 103 R1000	6.320

(1) Space for mechanical interlock included.

Note: The adapter plates provided for the A... contactors can be used for the AF, AE and TAE types.

Adapter Plates and Mounting Plates for A 95 ... AF 750 Contactors

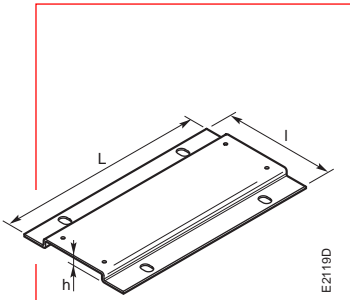

E2/19D

Dimensions (mm)

Type of the plate	Dimensions			Fixing holes mm
	L	l	h	
PR 110-1	151	106	11.2	2 x \varnothing 7
PR 145-1	180	122	11.5	4 x \varnothing 7
PR 210-1	200	132	11.5	4 x \varnothing 7
PR 300-1	200	172	11.5	4 x \varnothing 7
PR 460-1	278	198	11.5	4 x \varnothing 7
PR 750-1	283	244	11.5	4 x \varnothing 7
PR 185-2	202	152	11.2	4 x \varnothing 11
PR 300-2	202	152	11.2	4 x \varnothing 11
PR 400-2	278	151	11.5	4 x \varnothing 11
PR 460-2	278	176	11.5	4 x \varnothing 11
PR 580-2	283	176	11.5	4 x \varnothing 11
PR 750-2	283	255	11.5	4 x \varnothing 14

Note: Fixing holes according to the plate types.

>> Ordering Details page 4/31

Main Contact Sets Arc Chutes

Main Contact Sets for 3-pole Contactors

Description

The contact sets for 3-pole contactors consist of six fixed contacts, three moving contacts, springs and the required screws.

Ordering details

For contactors	Type	Order code	Pack ^{ing} set	Weight kg 1 piece
A/AF/AE/TAE 50-30	ZL 50	1SBN 163 503 R1000	1	0.115
A/AF/AE/TAE 63-30	ZL 63	1SBN 163 703 R1000	1	0.130
A/AF/AE/TAE 75-30	ZL 75	1SBN 164 103 R1000	1	0.145
A/AF/AE/TAE 95-30	ZL 95	1SFN 164 303 R1000	1	0.190
A/AF/AE/TAE 110-30	ZL 110	1SFN 164 503 R1000	1	0.190
A/AF 145	ZL 145	1SFN 164 703 R1000	1	0.380
A/AF 185	ZL 185	1SFN 164 903 R1000	1	0.380
A/AF 210	ZL 210	1SFN 165 103 R1000	1	0.670
A/AF 260	ZL 260	1SFN 165 303 R1000	1	0.670
A/AF 300	ZL 300	1SFN 165 503 R1000	1	0.670
AF 400	ZL 400	1SFN 165 703 R1000	1	1.320
AF 460	ZL 460	1SFN 165 903 R1000	1	1.320
AF 580	ZL 580	1SFN 166 103 R1000	1	1.840
AF 750	ZL 750	1SFN 166 303 R1000	1	1.840
AF 1350	ZL 1350	1SFN 166 503 R1000	1	2.500
AF 1650	ZL 1650	1SFN 166 703 R1000	1	3.500
UA 50	ZLU 50	1SBN 163 502 R1000	1	0.115
UA 63	ZLU 63	1SBN 163 702 R1000	1	0.145
UA 75	ZLU 75	1SBN 164 102 R1000	1	0.145
UA 95	ZLU 95	1SFN 164 302 R1000	1	0.190
UA 110	ZLU 110	1SFN 164 502 R1000	1	0.190

Note: GA, GAE 75, UA..RA contacts cannot be changed.

Main Contact Sets for 4-pole Contactors

Description

The contact sets for 4-pole contactors consist of eight fixed contacts, four moving contacts, springs and the necessary screws.

Ordering details

For contactors	Type	Order code	Pack ^{ing} set	Weight kg 1 piece
A/AE/AF 45-40	ZLT 45	1SBN 163 304 R1000	1	0.150
A/AE/AF 50-40	ZLT 50	1SBN 163 504 R1000	1	0.150
A/AE/AF 75-40	ZLT 75	1SBN 164 104 R1000	1	0.160

Arc Chutes

Ordering details

For contactors	Type	Order code	Pack ^{ing} set	Weight kg 1 piece
A/AF 145, A/AF 185	ZW 185	1SFN 164 710 R1000	1	0.360
A/AF 210 ... 300	ZW 300	1SFN 165 110 R1000	1	0.410
AF 400, AF 460	ZW 460	1SFN 165 710 R1000	1	1.380
AF 580, AF 750	ZW 750	1SFN 166 110 R1000	1	1.500
AF 1350, AF 1650	ZW 1650	1SFN 166 510 R1000	1	4.000

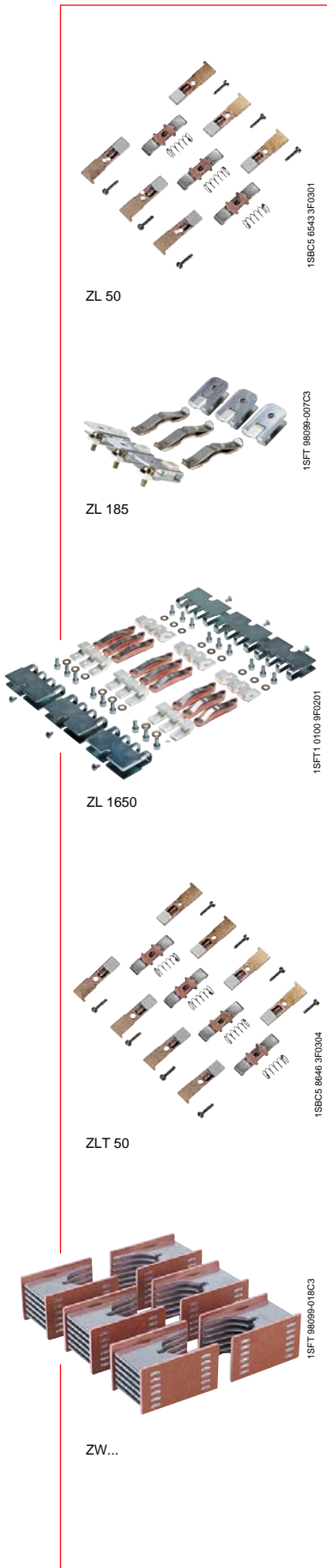

Contactors Coils

Ordering Details

a.c. Operated coils for A 9 ... A 300 contactors and N contactor relays

For contactors	Type	Order code	Packing pieces	Weight kg
	state coil voltage <input type="text"/> see page 0/1	state coil voltage code <input type="text"/> <input type="text"/> see page 0/1		1 piece
A 9 ... A 16 ; UA16 ; UA 16..RA ; N	ZA 16 <input type="text"/>	1SBN 151 410 R <input type="text"/> <input type="text"/> 06	1	0.093
A 26 ... A 40 ; UA 26, UA 30, UA 26..RA, UA 30..RA	ZA 40 <input type="text"/>	1SBN 152 410 R <input type="text"/> <input type="text"/> 06	1	0.148
A 45 ... A 75 ; UA 50 ... UA 75 UA 50..RA to UA 75..RA ; GA 75	ZA 75 <input type="text"/>	1SBN 153 510 R <input type="text"/> <input type="text"/> 06	1	0.166
A 95, A 110 ; UA 95, UA 110 UA 95..RA, UA 110..RA	ZA 110 <input type="text"/> ZA 185 <input type="text"/>	1SFN 154 310 R <input type="text"/> <input type="text"/> 06 1SFN 154 710 R <input type="text"/> <input type="text"/> 06	1 1	0.170 0.180
A 145 ... A 185 A 210 ... A 300	ZA 300 <input type="text"/>	1SFN 155 110 R <input type="text"/> <input type="text"/> 06	1	0.400

a.c. / d.c. Operated coils with electronic interface for AF 45 ... AF 1650 contactors

For contactors	Type	Order code	Packing pieces	Weight kg
	state coil voltage <input type="text"/> see page 0/1	state coil voltage code <input type="text"/> <input type="text"/> see page 0/1		1 piece
AF 45 ... AF 75	ZAF 75 <input type="text"/>	1SBN 153 570 R <input type="text"/> <input type="text"/> 06	1	0.170
AF 95, AF 110	ZAF 110 <input type="text"/>	1SFN 154 370 R <input type="text"/> <input type="text"/> 06	1	0.200
AF 145, AF 185	ZAF 185 <input type="text"/>	1SFN 154 770 R <input type="text"/> <input type="text"/> 06	1	0.225
AF 210 ... AF 300	ZAF 300 <input type="text"/>	1SFN 155 170 R <input type="text"/> <input type="text"/> 06	1	0.450
AF 400, AF 460	ZAF 460 <input type="text"/>	1SFN 155 770 R <input type="text"/> <input type="text"/> 06	1	0.525
AF 580, AF 750	ZAF 750 <input type="text"/>	1SFN 156 170 R <input type="text"/> <input type="text"/> 06	1	1.335
AF 1350, AF 1650	ZAF 1650 <input type="text"/> (1) ZP 1650 <input type="text"/> (2)	1SFN 156 570 R7026 1SFN 166 521 R1070	1 set 1	0.900 0.300

(1) One set of 2 coils - (2) Printed circuit board.

d.c. Operated coils for AE 45 ... AE 110 contactors (coils for AL..., NL... and other variants are not provided)

For contactors	Type	Order code	Packing pieces	Weight kg
	state coil voltage <input type="text"/> see page 0/1	state coil voltage code <input type="text"/> <input type="text"/> see page 0/1		1 piece
Coils only				
AE 45 ... AE 75 ; GAE 75	ZAE 75 <input type="text"/>	1SBN 153 590 R <input type="text"/> <input type="text"/> 06	1	0.170
AE 95, AE 110	ZAE 110 <input type="text"/>	1SFN 154 390 R <input type="text"/> <input type="text"/> 06	1	0.195

Note: d.c. operated coils for TAE... contactors: please consult us (standard AE contactor coils are not suitable for TAE contactors).

Auxiliary device including an insertion contact and a varistor

AE 95, AE 110, TAE 95, TAE 110	CCL 18-01	1SFN 014 328 R1001	1	0.040
--------------------------------	-----------	--------------------	---	-------

Note: CDL 5-01 contact block (factory mounted on AE 45 ... AE 75 and TAE 45 ... TAE 75 contactors) is not available for separate delivery.

d.c. Operated coil and diode for AM 45 ... AM 75 contactors

For contactors	Type	Order code	Packing pieces	Weight kg
	state coil voltage <input type="text"/> see page 0/1	state coil voltage code <input type="text"/> <input type="text"/> see page 0/1		1 piece
Coil				
AM 45 ... AM 75	ZAM 75 <input type="text"/>	1SBN 153 580 R <input type="text"/> <input type="text"/> 06	1	0.170
Diode				
AM 45 ... AM 75	RT5-AM	1SBN 050 021 R1000	2	0.015



ZA 16

1SBC5 7880 2F0302



ZA 185

1SFT 9809-010C3



ZAF 110

1SBC5 7888 3F0302



ZAF 300

1SFT 9800-013C3



ZA 1650

1SFC1 0100 7F0201

Auxiliary Contacts

Electrical Durability

Electrical Durability for AC-15 Utilization Category

AC-15 utilization category according to IEC 60947-5-1 / EN 60947-5-1:

- making current: $10 \times I_e$ with $\cos \varphi = 0.7$ and U_e
- breaking current: I_e with $\cos \varphi = 0.4$ and U_e

These curves represent the electrical durability of the built-in or add-on auxiliary contacts or pneumatic timer contacts, in relation to the breaking current.

The curves have been drawn for resistive and inductive loads up to 690 V, 40 ... 60 Hz.

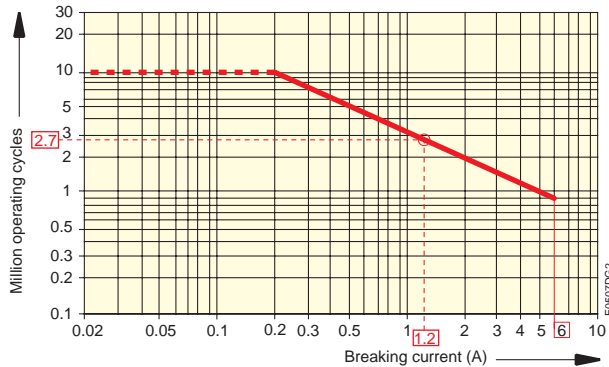

- A 9 ... A 40, AL 9 ... AL 40, AL 9Z ... AL 16Z, TAL 9 ... TAL 40 contactor built-in auxiliary contacts
- 1-pole and 4-pole CA 5-..., 1-pole CC 5-..., 2-pole CAL 5-..., CAL 18-.. and CCL 5-.. add-on auxiliary contacts.

Example:

Breaking current = 1.2 A

On the opposite curve at intersection "O" 1.2 A the corresponding value for the electrical durability is approximately $2.7 \cdot 10^6$ operating cycles.

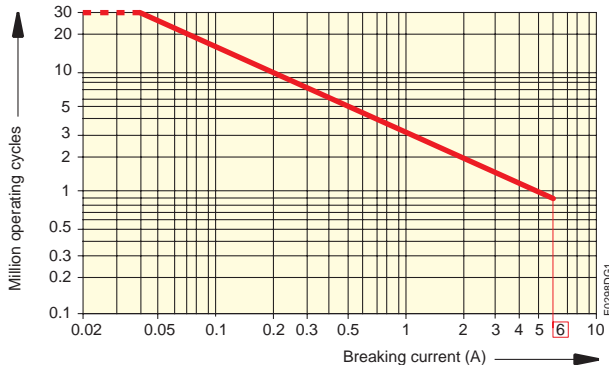

- N..., NL..., NL Z... and TNL... contactor relays. (For add-on auxiliary contacts see above curve).

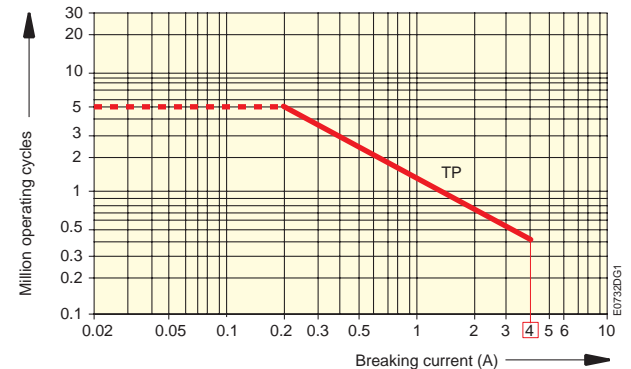

- TP... pneumatic timer contacts.

Electrical Durability for DC-13 Utilization Category

DC-13 utilization category according to IEC 60947-5-1 / EN 60947-5-1: making and breaking current = I_e with U_e value.

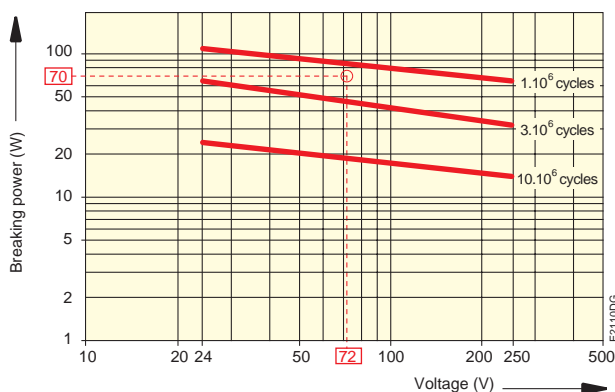

- A 9 ... A 40, AL 9 ... AL 40, AL 9Z ... AL 16Z, TAL 9 ... TAL 40 contactor built-in auxiliary contacts
- 1-pole and 4-pole CA 5-..., 1-pole CC 5-..., 2-pole CAL 5-..., CAL 18-.. and CCL 5-.. add-on auxiliary contacts.
- N..., NL..., NL Z and TNL... contactor relays,
- TP... pneumatic timer contacts

Example:

Control of d.c. electro-magnet: U_e voltage = 72 V d.c. and breaking power = 70 W.

On the opposite curve at intersection "O" 72 V / 70 W the corresponding value for the electrical durability is approximately 2.10^6 operating cycles.

Auxiliary Contact Blocks

Accessories for EK... Contactors

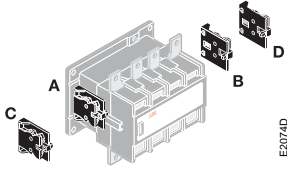

Mounting positions of the CAL 16-11

Application

Addition of auxiliary contacts on EK... contactors in side position for the self holding function or automation, alarms, etc.

Description

Auxiliary contact blocks are available in a 2-pole version with 1 N.O. and 1 N.C. contacts.

- **CAL...** : instantaneous, N.O. and N.C.
- **CCL...** : N.C. lagging + N.O. (overlapping contacts)

They are equipped with screw type connecting terminals delivered open and protected against accidental direct contact.

Mounting:

Screwed onto the right and / or lefthand side of the **EK 110** to **EK 1000** contactors.

Ordering Details

For contactors	Max. number of blocks	Contact blocks 	Type	Order code	Weight kg Pack ^{ing} 1 piece
2-pole auxiliary contact blocks					
EK ...	1 block	1 1 --	CAL 16-11 A	SK 829 002-A	0.050
	1 block	1 1 --	CAL 16-11 B	SK 829 002-B	0.050
	1 block	1 1 --	CAL 16-11 C	SK 829 002-C	0.050
	1 block	1 1 --	CAL 16-11 D	SK 829 002-D	0.050
	1 block	1 -- - 1	CCL 16-11 E ⁽¹⁾	SK 829 002-E	0.050





(1) Mounting of a **CCL 16-11 E** block does not allow an additional second block to be added on top of it. All d.c. operated EK... contactors are equipped with one CCL 16-11 E on the right side.

Auxiliary Contact Blocks

Accessories for EK... Contactors

Technical Data

Utilization characteristics according to IEC

Types	2-pole CAL 16-11	2-pole CCL 16-11
Compliance with standards	IEC 60947-5-1 and EN 60947-5-1	
Rated insulation voltage U_i according to IEC 60947-5-1	V 690	
Rated operational voltage U_e	V a.c. 24 ... 690	
Conventional thermal current I_{th}	A 10	
Rated operational current I_e acc. to IEC 60947-5-1		
AC-15	24-127 V	A 6
	220-240 V	A 6
	380-440 V	A 4
	500-690 V	A 1
DC-13	24 V	A 6
	48 V	A 6
	72 V	A 4
	125 V	A 1.8
	250 V	A 0.6
Short circuit protection (gG fuses)	A 10	
Making capacity	10 x I_e AC-15	
Breaking capacity	10 x I_e AC-15	
Rated short-time withstand current I_{cw}	1 s	A 50
$\theta = 40^\circ\text{C}$	0.1 s	A 100
Power loss per pole at 6 A	W 0.2	
Min. switching capacity	0.25 VA / 12 V or 0.25 VA / 5 mA	
Mechanical durability		
– million of operating cycles	10	
– max. mech. switching frequency	cycles /h 3600	
Electrical durability		
– million of operating cycles	see "Electrical Durability" curves	
– max. elec. switching frequency	cycles /h 1200	
Connecting terminals (Delivered in open position. Screws of unused terminals should be tightened.)	M3.5 (+,-) pozidriv 2 screws with cable clamp	
Tightening torque		
– recommended	Nm 1.00	
– max.	Nm 1.20	
Connecting capacity (min. ... max.)		
Rigid solid 	1 or 2 x mm ² 0.5 ... 2.5	
Flexible with cable end 	1 or 2 x mm ² 0.5 ... 2.5	
Flexible with sleeve 	1 or 2 x mm ² 0.5 ... 1.5	
Lugs 	L mm ≤	8
	l mm >	3.7
Degree of protection acc. to IEC 60947-1 / EN 60947-1 and IEC 60529 / EN 60529	IP 20	

Utilization characteristics according to UL/CSA

Max. rated voltage	V 600
Pilot duty	A600

>> Electrical Durability Curves page 4/45	>> Terminal Marking and Positioning section 8
>> Certification and Approvals section 7	>> Dimensions section 9

Mechanical Interlock Units

Mechanical and Electrical Interlock Units

Accessories for EK... Contactors



SK 829 070...



VH 145

Application

The mechanical interlock unit prevents one of the contactors from closing as long as while the other contactor is closed.

Description

- **VH 145, VH 300** interlock units for mechanical and electrical interlocking of two horizontal mounted a.c. or d.c. operated EK 110 ... EK 210 contactors.
- **VH 800** interlock unit for mechanical interlocking of two horizontal mounted a.c. or d.c. operated EK 370 ... EK 1000 contactors.

Ordering Details

For contactors	Type	Order code	Pack ^{ing} piece	Weight kg
Mechanical and electrical interlock units for two horizontal mounted contactors				
EK 110, EK 150	VH 145	SK 829 071-A	1	0.130
EK 175, EK 210	VH 300	SK 829 071-B	1	0.130
Mechanical interlock unit for two horizontal mounted contactors				
EK 370 ... EK 1000	VH 800	SK 829 070-F	1	6.000

Selection Table

Interlocking of two horizontal mounted contactors, a.c. or d.c. coil

Contactor types				
	Right	EK 110, EK 150	EK 175, EK 210	EK 370 ... EK 1000
Left				
EK 110, EK 150		VH 145	–	–
EK 175, EK 210		–	VH 300	–
EK 370 ... EK 1000		–	–	VH 800
Fixing		PN 210-22 mounting plate (to be supplied separately)	PN 300-22 mounting plate (to be supplied separately)	Mounting plate included

>> Accessory Fitting Details page 2/25
>> Dimensions section 9



>> Mounting plates page 4/43

Mechanical Interlock Units

Mechanical and Electrical Interlock Units

Accessories for EK... Contactors

Technical Data - VH 145 and VH 300 Mechanical and Electrical Interlock Units

Standards	IEC 60947-5-1, EN 60947-5-1		
Rated insulation voltage U_i according to IEC 60947-5-1	V		690
according to UL / CSA	V		600
Rated operational voltage U_e according to IEC 60947-5-1	V a.c.		24 ... 690
Conventional thermal current I_{th}	A		10
Rated operational current I_e according to IEC 60947-5-1			
AC-15			
24-127 V	A		6
220-240 V	A		6
380-440 V	A		4
500-690 V	A		1
DC-13			
24 V	A		6
48 V	A		6
72 V	A		4
125 V	A		1.8
250 V	A		0.6
Making capacity			10 x I_e AC-15
Breaking capacity			10 x I_e AC-15
Rated short-time withstand current I_{cw} $\theta = 40\text{ }^\circ\text{C}$			
		1 s	A 100
		0.1 s	A 140
Short-circuit protection gG type fuses	A		10
Heat loss per pole at 6 A	W		0.15
Mechanical durability		operating cycles	1 million
Max. switching frequency		cycles /h	600
Connecting capacity			
– rigid solid		1 or 2 x mm²	1 ... 2.5
– flexible with end		1 or 2 x mm²	0.75 ... 2.5
Connecting terminals delivered in open position (screws of unused terminals should be tightened)			M3.5 (+,-) pozidriv 2 screws with cable clamp
Tightening torque			
– recommended	Nm		1.00
– max.	Nm		1.20
Degree of protection acc. to IEC 60947-1 / EN 60947-1 and IEC 60529 / EN 60529			IP 20

Technical note

When, during switching, the arc time is estimated to more than 40 ms, the closing signal of one of the two contactors must be delayed with respect to the opening signal of the other contactor in order to prevent a short-circuit.

Use a TP 40 pneumatic timer or a TE5S electronic timer with time lapse, as applicable.

Surge Suppressors for Contactor Coils

Accessories for EK... Contactors

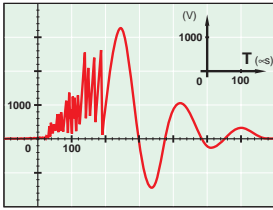

Application

The operation of inductive circuits causes overvoltages, in particular on opening of the contactor coil.

The electromagnetic energy stored by the coil during contactor closing is restored on opening in the form of surges, the slope and amplitude of which may rise to several kilovolts. A number of drawbacks are observed ranging from interference on the electronic devices to breakdown of insulators and even destruction of certain sensitive components.

The graph opposite reproduces the oscillogram showing voltage discharges at the terminals of a 42 V / 50 Hz coil without peak clipping. The coil was switched by 8 series-connected poles of a contactor relay.

Following a burst of discharges with a very steep slope a damped oscillation emerges with a peak value of 3500 V.

Overvoltage Factor

The overvoltage factor **k** is defined as the ratio of the maximum overvoltage peak value \hat{U}_s to the peak value \hat{U}_c of the coil rated control voltage U_c :

$$k = \frac{\hat{U}_s \text{ max.}}{\hat{U}_c} \quad \text{in d.c.: } k = \frac{\hat{U}_s \text{ max.}}{U_c} \quad \text{or in a.c.: } k = \frac{\hat{U}_s \text{ max.}}{U_c \sqrt{2}}$$

For example the following is obtained for the above graph: $k = \frac{3500}{42 \sqrt{2}} \approx 60$

Description

To reduce the harmful effects of these overvoltages, ABB has developed a range of surge suppressors designed to reduce the **k** factor defined above and to limit or even completely eliminate the high pre-damping voltage frequencies.

Each case is different, but the technical data tolerances and the generous sizing of parts have enabled us to reduce the number of variants.

We have chosen the following solutions: varistors and RC blocks.

Note: A varistor is a resistor whose value increases to a very large extent when a certain voltage is applied at its terminals.

Ordering Details

For contactors	Control voltage		Type	Order code	Pack ^{ing} Weight	
	V	d.c. a.c.			pieces	kg
EK 110 ... 210	24 ... 48	- ●	RC-EH 300/48	SK 829 007-A	1	0.015
	110 ... 415	- ●	RC-EH 300/415	SK 829 007-B	1	0.015
EK 370 ... 1000	48 ... 110	- ●	RC-EH 800/110	SK 829 007-C	1	0.015
EK 110 ... 1000	24 ... 125	● -		SK 829 007-D	1	0.015
EK 370 ... 1000	220 ... 600	- ●	RC-EH 800/600	SK 829 007-D	1	0.015



RC-EH 300/48

Surge Suppressors for Contactor Coils

Accessories for EK... Contactors

Technical Data

RC types	RC-EH 300/48	RC-EH 300/415
Control voltage U_c <small>(clipping voltage)</small>	V a.c. 24 ... 48	V a.c. 110 ... 415
Residual overvoltage <small>(clipping voltage)</small>	V a.c. 2 to 3 x U_c	
Opening time growth factor	1.2 ... 3	
Operating temperature	°C -20 ... +70	
Connection to the coil terminal <small>(parallel mounting)</small>	Flexible, accessible leads, equipped with forked lugs	
Fixing	Glued to the top part of the contactor base	
Advantages	<ul style="list-style-type: none"> ● Very fast clipping ● Attenuation of steep fronts and thus of high frequencies ● No operating delays 	

Varistor + RC	RC-EH 800/110	RC-EH 800/600
Control voltage U_c <small>(clipping voltage)</small>	V a.c. 48 ... 110 V d.c. 24 ... 125	V a.c. 220 ... 600 V d.c. -
Residual overvoltage	V a.c. 205 V d.c. 205	V a.c. 1100 V d.c. -
Opening time growth factor	1.1 ... 1.15	
Operating temperature	°C -20 ... +70	
Connection to the coil terminal <small>(parallel mounting)</small>	Flexible, accessible leads, equipped with forked lugs	
Fixing	Glued to the top part of the contactor base	
Advantages	<ul style="list-style-type: none"> ● High energy absorption: good damping ● Unpolarized system ● The RC system damps the voltage front under the U_{vdr}^* threshold. 	

* U_{vdr} = Varistor operating voltage (voltage dependent resistor), tolerance $\pm 10\%$

Wiring Diagrams

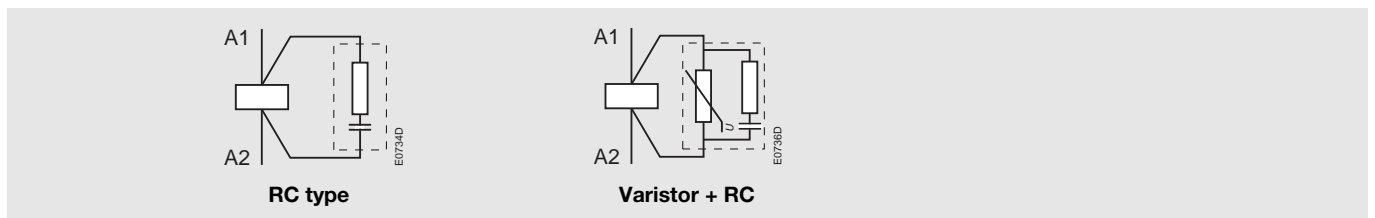

Dimensions (in mm)

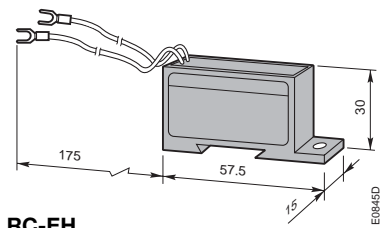

RC-EH

Terminal Shrouds - Connection Sets

Accessories for EK... Contactors

Terminal Shrouds

Application

The use of terminal shrouds on the main terminals of **EK...** contactors is required in electrical panels or cubicles to be built in compliance with the rules for protection against accidental direct contact with live parts in acc. with EN 50274.

Description

On **EK 110 ... EK 1000** contactors:

- The auxiliary contact blocks and coils are designed to provide an IP 20 degree of protection.
- The main terminals, equipped with lugs or connectors, can be protected against accidental direct contact after wiring (EN 50274) by the addition of terminal shrouds (see table below).

Each terminal shroud protects all the terminals on one side of the contactor. Two terminal shrouds should be provided for each separate contactor.

Ordering details

Mounting on contactor (with lugs or connectors)	Type	Order code	Pack ^{ing} pieces	Weight kg
EK 110, EK 150	LT 150-EK	SK 178 001-HB	1	0.139
EK 175, EK 210	LT 210-EK	SK 178 001-KB	1	0.152
EK 370, EK 550	LT 550-EK	SK 178 001-LB	1	0.190
EK 1000	LT 1000-EK	SK 178 001-MB	1	0.200



LT 210-EK

1SFC1 0100 2R0201C3

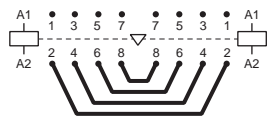

BSS 100 ... BSS 1000

E0747D

Connection Sets

Application

Connection between the main poles of **two 4-pole contactors** mounted side by side so that they operate as source reversing contactors.

Description

These sets are made up of four downstream connections.

- BSS 100 ... BSS 210** – Insulated, flexible copper bars.
- BSS 550, BSS 1000** – Bare, solid copper bars.

Ordering details

Mounting on 4-pole contactors	Type	Order code	Pack ^{ing} set	Weight kg
EK 110	BSS 100	SK 829 090-B	1	0.400
EK 150	BSS 145	SK 829 090-F	1	0.700
EK 175, 210	BSS 210	SK 829 090-G	1	1.000
EK 370, 550	BSS 550	SK 829 090-E	1	3.300
EK 1000	BSS 1000	SK 829 090-H	1	5.500

Mounting Plates

Accessories for EK... Contactors

Application

Plates for two horizontal mounted contactors with or without a mechanical interlock unit.

Ordering details

To use with:			Type	Order code	Weight kg Pack ^{ing} 1 piece
Lefthand contactor	Mechanical interlock	Righthand contactor			
EK 110, EK150	VH 145	EK 110, EK150	PN 210-22	SK 829 075-C	1.400
EK 175, EK 210	VH 300	EK 175, EK 210	PN 300-22	SK 829 075-E	2.070



PN...

Dimensions (in mm)

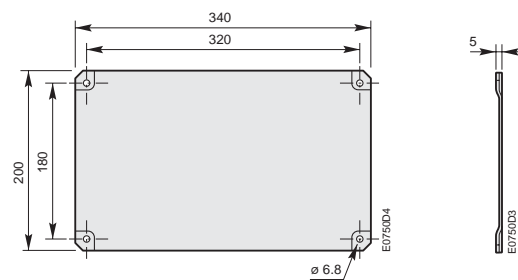

PN 210-22

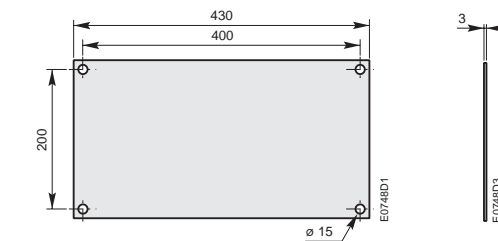

PN 300-22

Main Contact Sets - Arc Chutes - Contactor Coils

Accessories for EK... Contactors

Main Contact Sets for 4-pole Contactors

Description

The contact sets for 4-pole contactors consist of eight fixed contacts, four moving contacts, springs and the necessary screws. In addition, the sets include four moving arcing contacts for **EK 370 ... EK 1000** contactors.

Ordering details

For contactors	Type	Order code	Pack ^{ing} set	Weight kg
EK 110	KZK 110	SK 824 204-A	1	0.450
EK 150	KZK 150	SK 824 204-B	1	0.450
EK 175	KZK 175	SK 825 204-A	1	0.700
EK 210	KZK 210	SK 825 204-B	1	0.700
EK 370	KZK 370	SK 827 204-A	1	2.400
EK 550	KZK 550	SK 827 204-B	1	2.400
EK 1000	KZK 1000	SK 827 204-F	1	3.000

Arc Chutes

Ordering details

For contactors	Type	Order code	Pack ^{ing} set	Weight kg
EK 110	KWK 110	5223 351-AH	1	0.660
EK 150	KWK 150	5223 351-AK	1	0.660
EK 175	KWK 175	5223 351-AL	1	1.260
EK 210	KWK 210	5223 351-AM	1	1.260
EK 370	KWK 370	5223 351-Y	1	3.170
EK 550	KWK 550	5223 351-Z	1	3.170
EK 1000	KWK 1000	5223 351-AN	1	3.170

Contactors Coils

Ordering details

For contactors	Type	Order code	Pack ^{ing} piece or set	Weight kg
	state coil voltage <input type="text"/> <input type="text"/> <input type="text"/> see page 0/1	state coil voltage code <input type="checkbox"/> <input type="checkbox"/> see page 0/1		

a.c. or d.c. coils only

EK 110, EK 150	KH 210 <input type="text"/> <input type="text"/> <input type="text"/>	SK 825 400 - <input type="checkbox"/> <input type="checkbox"/>	1	0.360
EK 175, EK 210	KH 300 <input type="text"/> <input type="text"/> <input type="text"/>	SK 826 400 - <input type="checkbox"/> <input type="checkbox"/>	1	0.440
EK 370, EK 550, EK 1000	KH 800 <input type="text"/> <input type="text"/> <input type="text"/>	SK 828 100 - <input type="checkbox"/> <input type="checkbox"/>	1	0.950

Sets including a d.c. coil, an economy resistor and an insertion contact

EK 110, 150	KP 210 <input type="text"/> <input type="text"/> <input type="text"/> (1)	SK 825 450 - <input type="checkbox"/> <input type="checkbox"/>	1 set	0.450
EK 175, 210	KP 300 <input type="text"/> <input type="text"/> <input type="text"/> (1)	SK 826 450 - <input type="checkbox"/> <input type="checkbox"/>	1 set	0.550
EK 370, EK 550, EK 1000	KP 800 <input type="text"/> <input type="text"/> <input type="text"/>	SK 828 150 - <input type="checkbox"/> <input type="checkbox"/>	1 set	1.060

(1) The KP 210 and KP 300 have a double coil winding instead of an economy resistor.

Sets including a multi-frequency coil and an insertion contact for contactor with built-in rectifier

EK 110, EK 150	KP 210 <input type="text"/> <input type="text"/> <input type="text"/>	SK 825 450 - E <input type="checkbox"/>	1 set	0.450
EK 175, EK 210	KP 300 <input type="text"/> <input type="text"/> <input type="text"/>	SK 826 450 - E <input type="checkbox"/>	1 set	0.550



KZK 370

1SBC5 8647 3F0304



KH 300

1SBC5 7361 3F0302

Auxiliary Contacts for EK... Contactors

Electrical Durability

Electrical Durability for AC-15 Utilization Category

AC-15 utilization category according to IEC 60947-5-1 / EN 60947-5-1:

- making current: $10 \times I_e$ with $\cos \varphi = 0.7$ and U_e
- breaking current: I_e with $\cos \varphi = 0.4$ and U_e

This curve represents the electrical durability of the auxiliary contacts in relation to the breaking current.

The curve has been drawn for resistive and inductive loads up to 690 V, 40 ... 60 Hz.

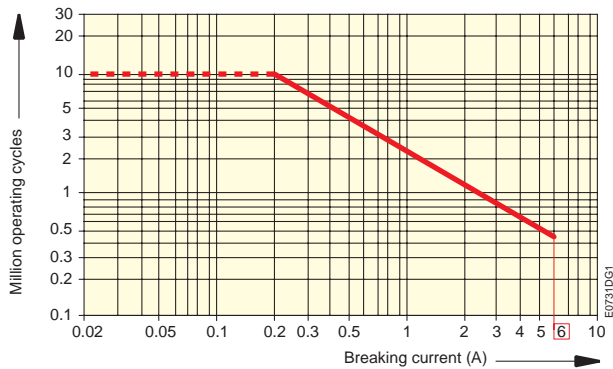

2-pole CAL 16... and CCL 16... auxiliary contact blocks

Electrical Durability for DC-13 Utilization Category

DC-13 utilization category according to IEC 60947-5-1 / EN 60947-5-1:

making and breaking current = I_e with U_e value.

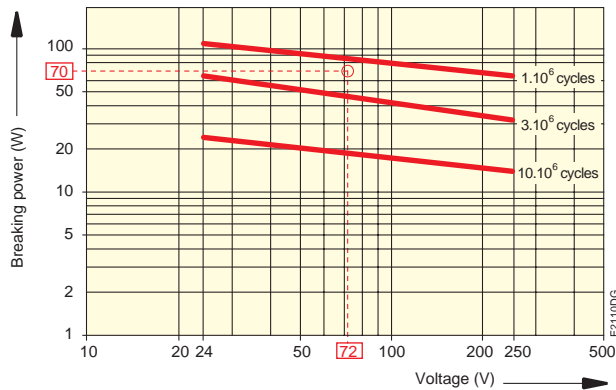

2-pole CAL 16... and CCL 16... auxiliary contact blocks

Example:

Control of d.c. electro-magnet: U_e voltage = 72 V d.c. and breaking power = 70 W.

On the opposite curve at intersection "O" 72 V / 70 W the corresponding value for the electrical durability is approximately $2 \cdot 10^6$ cycles.